



protect. teach. love.®

Operating Guide

PIG00-14673

Rechargeable In-Ground Fence™

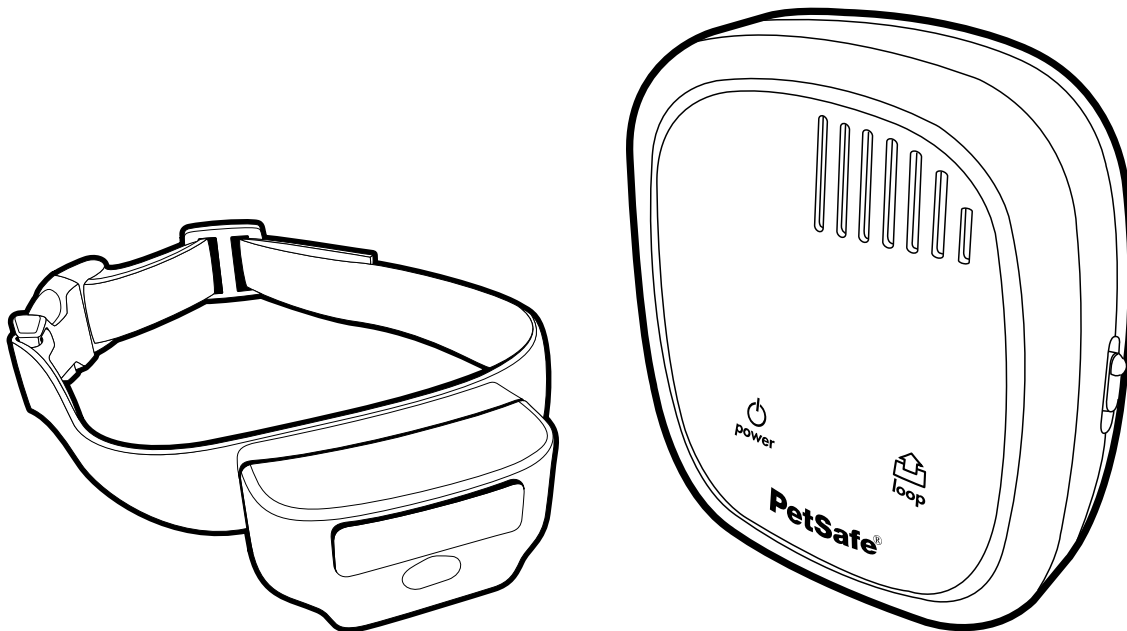

Please read this entire guide before beginning

Thank you for choosing PetSafe® Brand. You and your pet deserve a companionship that includes memorable moments and a shared understanding. Our products provide you with the tools and technologies to successfully train your pet. If you have any questions about our products or training your pet, please visit our website at www.petsafe.net or contact our Customer Care Center at 1-800-732-2677. To get the most protection out of your warranty, please register your product within 30 days at www.petsafe.net. By registering and keeping your receipt, you will enjoy the product's full warranty and should you ever need to call the Customer Care Center, we will be able to help you faster. Most importantly, we will never give or sell your valuable information to anyone. Complete warranty information is available online at www.petsafe.net.

Hereinafter Radio Systems Corporation, Radio Systems PetSafe Europe Ltd., Radio Systems Australia Pty Ltd. and any other affiliate or brand of Radio Systems Corporation may be referred to collectively as "We" or "Us."

Important Safety Information

Explanation of attention words and symbols used in this guide

 This is the safety alert symbol. It is used to alert you to potential personal injury hazards. Obey all safety messages that follow this symbol to avoid possible injury or death.

⚠ WARNING **WARNING** indicates a hazardous situation which, if not avoided, could result in death or serious injury.

⚠ CAUTION **CAUTION**, used with the safety alert symbol, indicates a hazardous situation which, if not avoided, could result in minor or moderate injury.

CAUTION **CAUTION**, used without the safety alert symbol, indicates a hazardous situation which, if not avoided, could result in harm to your pet.

NOTICE **NOTICE** is used to address practices not related to personal injury.

- ⚠ WARNING**
- Not for use with aggressive dogs. Do not use this product if your dog is prone to aggressive behavior. Aggressive dogs can cause severe injury or death to their owners and others. If you are not sure that this product is right for your dog, please talk to your veterinarian or a certified trainer.
 - Underground cables can carry high voltage. Have all underground cables marked before you dig to bury your wire. In most areas this is a free service. Avoid these cables when you dig.
 - This device contains a Lithium-Ion (Li-Ion) battery; never incinerate, puncture, deform, short-circuit, or charge with an inappropriate charger. Fire, explosion, property damage, or bodily harm may occur if this warning is not followed.
 - The battery should be charged in areas with temperatures ranging from 32°F to 113°F / 0°C to 45°C. Recharging the battery outside of this temperature range can cause the battery to overheat, explode or catch fire.
 - Follow all safety instructions for your power tools. Be sure to always wear your safety goggles.
 - Do not install, connect or remove your system during a lightning storm. If the storm is close enough for you to hear thunder, it is close enough to create hazardous surges.
 - Risk of electric shock. Use the fence transmitter and surge protector indoors in dry location only.
 - Turn off the power to the outlet before you install or remove your surge protector.
 - Risk of electrical shock or fire. Use the surge protector only with a duplex outlet with a center screw. Attach the unit with the long screw supplied.

⚠ CAUTION

- Risk of injury. Wire placed on top of the ground may be a trip hazard; use care in how you place your wires.

CAUTION

This PetSafe® Rechargeable In-Ground Fence™ system is not a solid barrier. This system is designed to act as a deterrent to remind pets, by static correction, to remain in the boundary established. It is important that you reinforce training with your pet on a regular basis. Proper fit of the receiver collar is important. A receiver collar worn for too long or made too tight on the pet's neck may cause skin damage, ranging from redness to pressure ulcers; this condition is commonly known as bed sores.

- **Avoid leaving the receiver collar on the dog for more than 12 hours per day.**
- When possible reposition the receiver collar on the pet's neck every 1 to 2 hours.
- Check the fit to prevent excessive pressure; follow the instructions in this manual.
- When using a separate collar for a leash, do not put pressure on the receiver collar.
- Wash the dog's neck area and the contact points of the receiver collar weekly with a damp cloth.
- Examine the contact area daily for signs of a rash or a sore.
- If a rash or sore is found, discontinue use of the receiver collar until the skin has healed.
- If the condition persists beyond 48 hours, see your veterinarian.
- For additional information on bed sores and pressure necrosis, please visit our website.

These steps will help keep your pet secure and comfortable. Millions of pets are comfortable while they wear stainless steel contact points. Some pets are sensitive to contact pressure. You may find after some time that your pet is very tolerant of the receiver collar. If so, you may relax some of these precautions. It is important to continue daily checks of the contact area. If redness or sores are found, discontinue use until the skin has fully healed.

You may need to trim the hair in the area of the contact points. Never shave the dog's neck; this may lead to a rash or infection.

- The receiver collar should not be on your dog when the system is tested. Your pet may receive an unintended correction.
- The boundary width of the system must be tested whenever an adjustment is made to the pet area to prevent unintended corrections to your pet.
- If you use a collar and leash for training, be sure the extra collar does not put pressure on the contact points.
- Always remove your dog's receiver collar before performing any transmitter testing.
- If possible, DO NOT use an AC circuit protected with a Ground Fault Circuit Interrupter (GFCI) or Residual Current Device (RCD). In rare cases, nearby lightning strikes may cause the GFCI or RCD to trip. Without power your dog may be vulnerable to escape. You will have to reset the GFCI or RCD to restore power to the system.

Do not install the surge protector if there is not at least 30 ft. (10 m) or more of wire between the electrical outlet and electrical service panel.

NOTICE

- Plug the surge protector into a grounded (3-prong) outlet that is within 5 ft. of the fence transmitter. ALWAYS use a grounded (3-prong) outlet to ensure maximum protection.
- Do not remove the ground prong from the surge protector plug. Do not use a 3-prong plug to 2-prong outlet converter. Doing so will make the surge protector ineffective against surges or spikes.
- You should expect hundreds of recharge cycles from your battery. However, do not charge your receiver collar every night. Charging too often can reduce battery life. Charge your receiver collar when the receiver indicator light blinks red.
- Use care when mowing or trimming your grass not to cut the loop wire.
- Verify that the boundary loop and transmitter wires connect to the proper surge protector terminals. Reversed connections will result in an increased risk of surge related damage.
- For added protection, when unused for long periods of time or prior to thunderstorms, unplug from the wall outlet and disconnect the loop boundary wires. This will prevent damage to the transmitter due to surges.
- To prevent an unintended correction, after the boundary flags have been placed, be sure to set the static correction on the receiver collar back to level 1, which is tone only.

Table of Contents

Components.....	6
Other Items You May Need.....	6
How the System Works.....	7
Key Definitions.....	7
Operating Guide	8
Step 1: Have Your Utilities Marked.....	8
Step 2: Charge the Receiver Collar.....	8
Step 3: Install the Surge Protector and Transmitter.....	8
Step 4: Design Your Boundary Zone.....	10
Step 5: Position, Twist and Splice the Boundary Wire.....	13
Step 6: Connect the Wires.....	14
Step 7: Prepare the Receiver Collar.....	16
Step 8: Set the Boundary Width and Test the Receiver Collar.....	18
Step 9: Bury the Boundary Wire.....	20
Step 10: Place the Boundary Flags.....	21
Step 11: Fit the Receiver Collar.....	22
Training Guide	24
Day 1—Tone-only Training for Boundary Awareness.....	25
Days 2 Through 4—Boundary Awareness with Static Correction.....	26
Days 5 Through 8—Distraction Phase.....	26
Days 9 Through 14—Unleashed Supervision.....	27
Days 15 Through 30—Pet Monitoring.....	28
Taking Your Pet Out of the Pet Area.....	28
Accessories.....	28
System Test.....	29
Wire Break Location Test.....	30
Troubleshooting	32
Terms of Use and Limitation of Liability.....	33
Compliance.....	34
Customer Care International.....	34
Battery Disposal.....	34
Warranty	35

Components

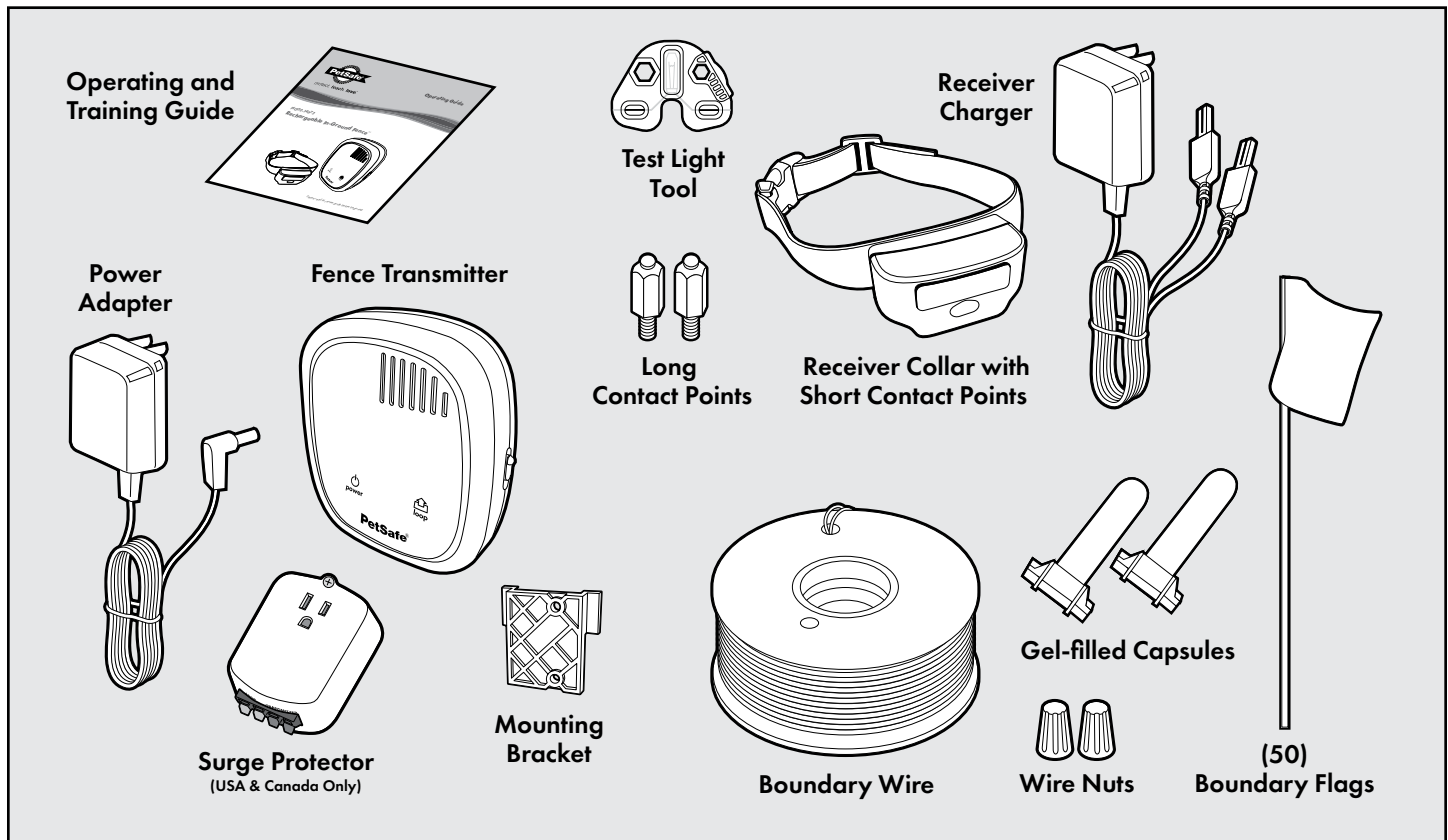

Other Items You May Need

- Additional wire and flags (Part #PIG00-13769)
- Additional wire nuts and gel-filled splice capsules
- Drill and mounting hardware
- Tape measure
- Small Phillips screwdriver
- Pliers
- Staple gun
- Scissors
- Lighter
- Shovel or lawn edger
- Wire stripping pliers
- Waterproofing compound (e.g. silicone caulk)
- PVC pipe or water hose
- Circular saw with masonry blade
- Non-metallic collar and leash

Setup and training help: www.petsafe.net

How the System Works

A radio signal travels from the fence transmitter through a buried wire, marking the boundaries you wish to set for your dog. Your dog wears a receiver collar that detects the signal at the boundary. As your dog approaches the boundary, the receiver issues a warning tone. If he proceeds further, he receives a safe but startling static correction. While harmless, the correction will persuade him to stay in the containment area you have established. Boundary flags are a temporary visual aid for your pet; remove them after training. This PetSafe® Rechargeable In-Ground Fence™ system has been proven safe, comfortable and effective for pets over 5 pounds.

Key Definitions

Fence Transmitter: Transmits the radio signal through the boundary wire.

Pet Area: The area within the warning zone where your pet can roam freely.

Warning Zone: The outer edge of the pet area where your pet's receiver collar begins to beep, warning him not to go into the static correction zone.

Static Correction Zone: The zone beyond the warning zone where your pet's receiver collar will emit a static correction, signaling him to return to the pet area.

Boundary Width: The combination of the warning zone and the static correction zone.

Surge Protector: Installed with the fence transmitter to protect it from lightning strikes and power surges (USA and Canada only).

Receiver Collar: Receives the radio signal from the boundary wire.

Mode Button: Turns the receiver on/off and adjusts the level of static correction that your pet receives outside the pet area.

Receiver Indicator Light: Indicates the level of correction at which the receiver collar is set. This light also indicates battery status.

Contact Points: Delivers the safe static correction when your pet moves into the static correction zone.

Receiver Charger: Charges the batteries inside the receiver collar.

Receiver Charge Jack: The connection point for charging the receiver battery.

Power Jack: Where the power adapter plugs into the fence transmitter.

Boundary Control Switch: The switch located on the fence transmitter to adjust according to the length of boundary wire used.

Boundary Wire Terminals: Where the boundary wires connect to the fence transmitter in order to complete a continuous loop.

Loop Indicator Light: Indicates that the boundary wire makes a complete loop, enabling the signal to be transmitted.

Boundary Width Control: Adjusts the width of the warning and static correction zones.

Note: Adjusting the knob does not change the level of static correction on the receiver collar.

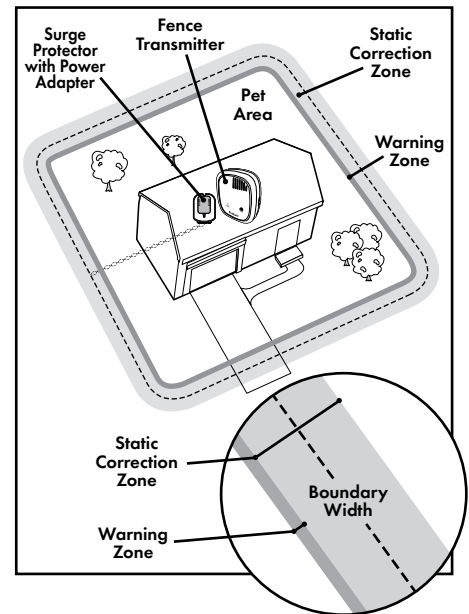

Receiver Collar

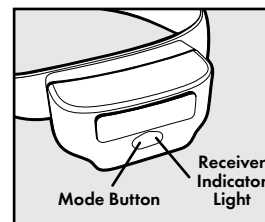
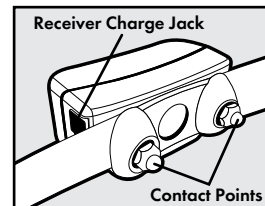

Fence Transmitter

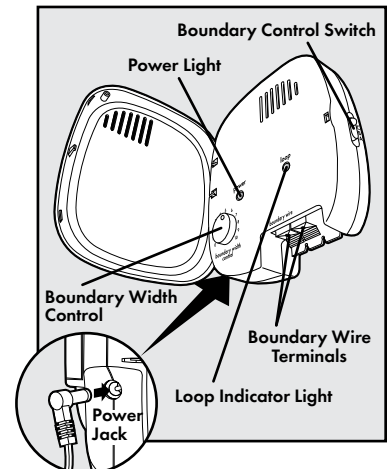

Operating Guide

Step 1: Have Your Utilities Marked

1. Call your utility company to have your utility lines marked. If you have neighbors using an in-ground pet containment system, you will want to ask them where the boundary is located. Trust us, you really do not want to skip this step.
2. Make a plan for how you will work around any large metal objects (like sheds) or wires. You can cross utility lines but only at 90° angles (**1A**).

Note: Large metal objects and wires can amplify and/or modulate radio signals in unpredictable ways.

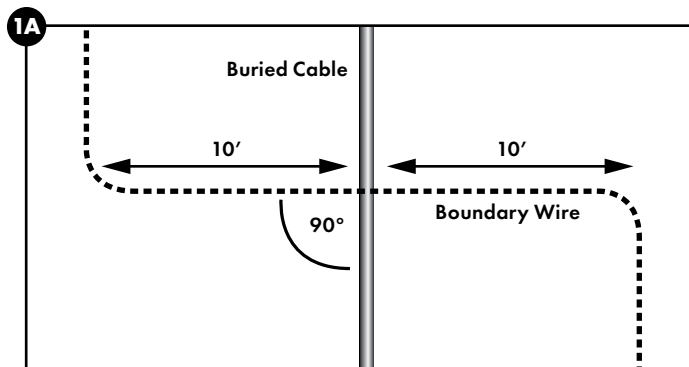

⚠ WARNING

Underground cables can carry high voltage. Have all underground cables marked before you dig to bury your wire. In most areas, this is a free service. Avoid these cables when you dig.

Step 2: Charge the Receiver Collar

The receiver charger has two jacks that allow you to charge two receiver collars at the same time. To charge the receiver collar, lift the rubber plug to allow access to the charge jack (**2A**). The rubber plug needs to remain attached to the receiver collar. Plug one end of the charger into the outlet and the other into the receiver collar. The jack and charger are keyed to fit one way. Do not force it in backwards. The collar light is red while charging and green when fully charged. A built in safety circuit prevents the receiver collar from overcharging. The first charge will take about 2 or 3 hours. Each charge can last up to 3 months depending on the frequency of use.

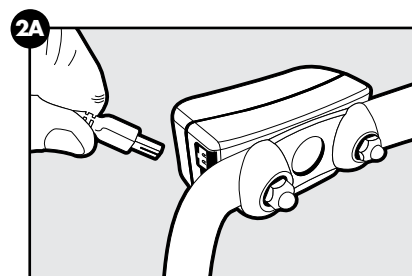

- The rechargeable Lithium Ion (Li-Ion) battery is not memory sensitive, does not require depletion before charging, and cannot be over charged.
- The battery comes partially charged from the factory, but will require a full charge before first use.
- When storing the unit for long periods, remember to regularly give the battery a full charge. This should be done once every 3 to 4 months.

⚠ WARNING

- This device contains a Lithium-Ion (Li-Ion) battery. Never incinerate, puncture, deform, short-circuit, or charge with an inappropriate charger. Fire, explosion, property damage, or bodily harm may occur if this warning is not followed.
- The battery should be charged in areas with temperatures ranging from 32°F to 113°F / 0°C to 45°C. Recharging the battery outside of this temperature range can cause the battery to overheat, explode or catch fire.

NOTICE

- You should expect hundreds of recharge cycles from your battery. However, do not charge your receiver collar every night. Frequent charging can have a negative effect on the battery. We recommend that the receiver collar be used until the receiver indicator light blinks red.

Step 3: Install the Surge Protector and Transmitter

Lightning strikes that occur even several miles away from your installation can create power surges or spikes which may damage an unprotected system. The surge protector is included to safeguard your Rechargeable In-Ground Fence™ system against surges or spikes that can reach it via your AC power connection and/or boundary wire. Find a place to install the surge protector and transmitter. There are a few things to consider when choosing an outlet for your surge protector and transmitter:

- We recommend using an outlet at least 30 ft. from the breaker box.
- Both the surge protector and transmitter should be indoors, in a dry, ventilated and protected area (**3A, 3B**).
- You will need to run wire from the transmitter to the boundary wire, so it must be near window or a wall that you can drill through (**3A**). The wire should not be pinched or cross any utility lines.
- The temperatures in that location should not fall below -10°F or -23°C.
- Both the surge protector and transmitter should be at least 3 ft. from large metal objects or appliances (**3C**). These items may interfere with the signal consistency.
- In case your system sounds an alarm, place it where you will be able to hear and access it.

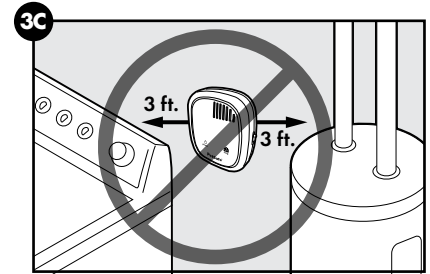
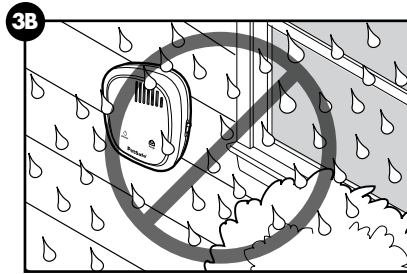
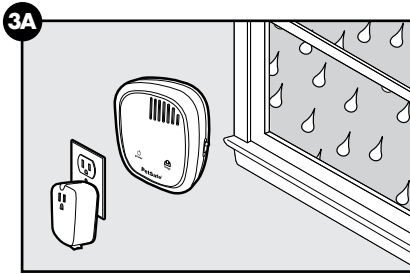

To mount the fence transmitter, screw the mounting bracket onto a stationary surface such as a wall, and slide the fence transmitter onto the bracket. Once you have mounted the fence transmitter, the boundary wire must exit the building. This can be accomplished via a window or through a hole drilled through the wall. Ensure the drill path is clear of any utilities. Make sure the boundary wire is not cut off or pinched by a window, door, or garage door, as this can damage it over time.

To prevent fires and electrical hazards, install the fence transmitter in buildings that are in accordance with state and local electrical codes.

⚠ WARNING

- Do not install, connect or remove your system during a lightning storm. If the storm is close enough for you to hear thunder, it is close enough to create hazardous surges.
- Risk of electric shock. Use the fence transmitter and surge protector indoors in dry location only.
- Turn off power to the outlet before you install or remove your surge protector.
- Risk of electric shock or fire. Use surge protector only with a duplex outlet with center screw.

CAUTION

- Do not install the surge protector if there is not at least 30 ft. (10 m) or more of wire between the electrical outlet and electrical service panel.
- If possible, **DO NOT** use an AC circuit protected with a GFCI (ground fault circuit interrupter). Both the surge protector and the fence system will function. However, in rare cases, nearby lightning may cause the GFCI to trip. Without power, your pet may escape. You will have to reset the GFCI to restore power to the system.

NOTICE

- Plug the surge protector into a grounded (3-prong) outlet within 5 ft. of the fence transmitter. **ALWAYS** use a grounded (3-prong) outlet to ensure protection.
- Do not remove the ground prong from the surge protector plug. Do not use a 3-prong plug to 2-prong outlet converter. Doing so will make the surge protector ineffective against surges or spikes.
- For added protection, when unused for long periods of time or prior to thunderstorms, unplug from the wall outlet and disconnect the loop boundary wires. This will prevent damage to the transmitter due to surges.

Step 4: Design Your Boundary Zone

Basic Planning Tips

- Always design your layout, position the boundary wire and test the system as outlined in this guide before burying the boundary wire. You do not want to find out after burying the wire that there is a problem with your layout or a loose connection somewhere.
- Sample layouts are provided in this section, and a grid for designing your layout is provided on the back of this guide.
- The boundary wire must start at the fence transmitter and make a continuous loop back **(4A)**.
- Always use gradual turns at the corners with a minimum of 3 ft. radius to produce a more consistent boundary **(4B)**. Do not use sharp turns; this will cause gaps in your boundary.
- Create areas in your yard that allow your pet to safely cross over the boundary wire without static correction by twisting the boundary wires together 10 to 12 times per ft. **(4C)**. This cancels the signal and allows your pet to safely cross over that area.
- To properly contain your pet, we recommend setting a boundary width for the warning and static correction zones to approximately 12–20 ft. (6 to 10 ft. on each side of the wire).
- Avoid making passageways too narrow for your pet to move about freely (e.g., along the sides of a house).
- The receiver collar can be activated inside the house if the boundary wire runs along the outside wall of the house. If this occurs, remove your pet's receiver collar before bringing him inside, decrease the range using the boundary width control knob or consider an alternate layout.

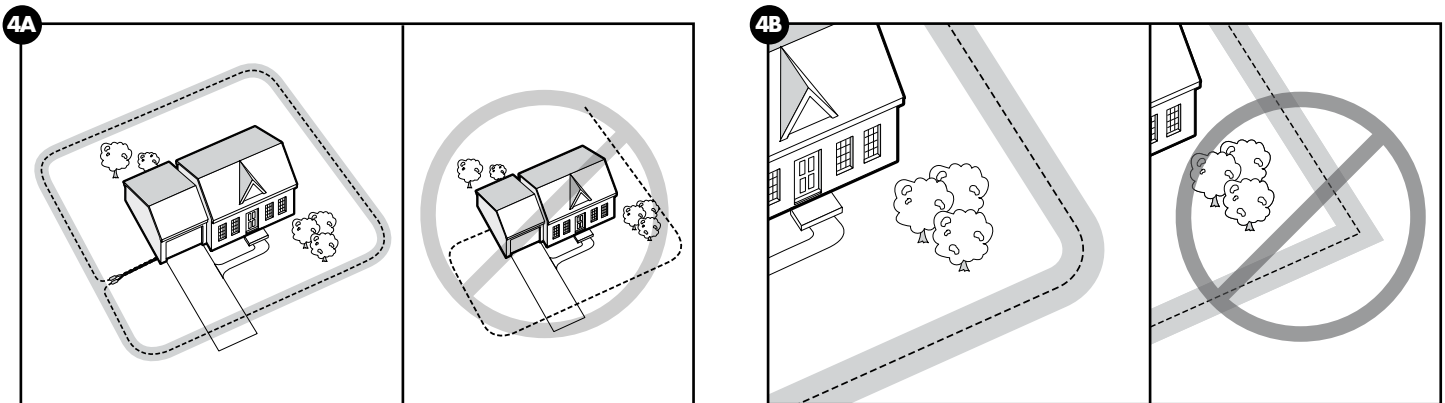

Single or Double Loop Layout

The containment area can be created by using either a single boundary wire that is placed around the entire property (4C) or by doubling the boundary wire along the same path (4E).

Single Loop Boundary

- To create a containment area for the entire property
- For exclusion areas around gardens, landscaping or pools

With a single loop layout, the boundary wire starts at the fence transmitter, advances out to the yard, continues all the way around the perimeter of the property and connects back to the fence transmitter. This forms a boundary zone with a single wire.

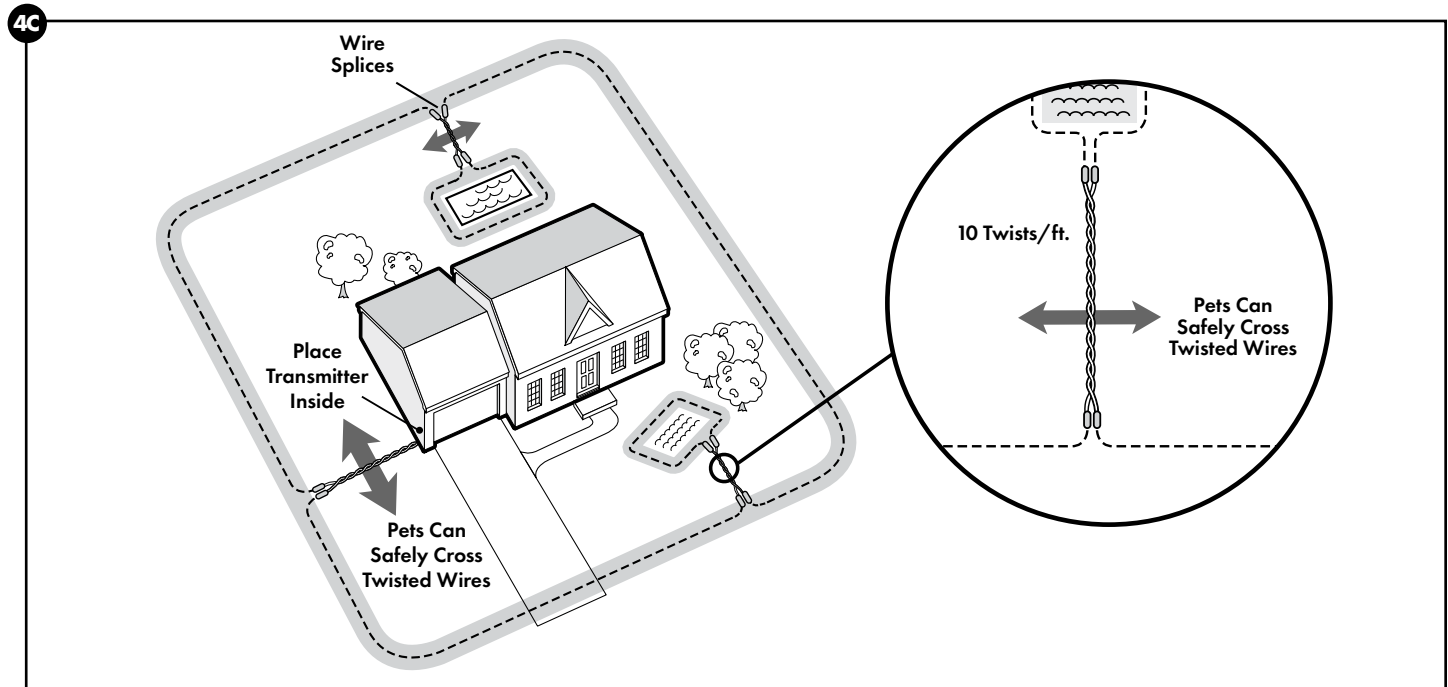

Sample 1: Perimeter Loop (4C) The perimeter loop is the most common layout. This will allow your pet to freely and safely roam your entire property. It can also protect gardens, pools and landscaping.

Sample 2: Full Perimeter Loop Using Existing Fence (4D) This layout allows you to include your existing fence as part of your layout and keep your pet from jumping out or digging under your existing fence. This layout also greatly reduces the installation time since most of the wire will not need to be buried.

Run the wire from the fence transmitter to point **A**, then to point **B** and so on (**B** to **C** to **D** to **E**) all the way around the entire property until back to point **A** again. The wires from point **A** will then need to be twisted and connected back to the fence transmitter inside your home.

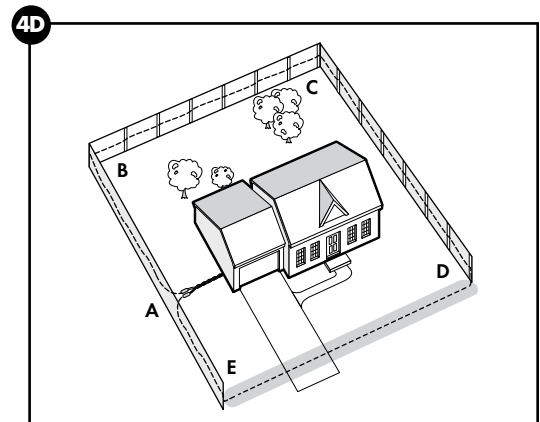

Double Loop Boundary

- To section off only one boundary area or one section of your yard (e.g., front yard only, or waterfront property)
- The 2 parallel sections of the double boundary wire must be separated by a minimum of **approximately 5 ft.** from each other in order to avoid canceling out the signal as well as provide an adequate boundary width (4E)
- A double loop layout requires twice as much wire as a single loop layout because it doubles back along the same path

With a double loop layout, the boundary wire starts at the fence transmitter, advances out to the yard and continues to form a boundary zone in one section of your property (e.g., front yard only). Then the wire makes a U-turn back along the same path and connects back to the fence transmitter. This forms a boundary zone with a double wire.

Sample 3 (4E): Front Yard or Back Yard Only (Double Loop)

From the fence transmitter, run the wire to point **A**, then to point **B** and so on (**B** to **C** to **D** to **E** to **F**). Next, make a U-turn and follow your path all the way back to point **G**, keeping the wire separated by at least 5 ft. When you get back to the house (**G**), make a sharp turn along the side of the house back to point **A**. Finally, twist the wires from point **A** and connect them back to the fence transmitter.

Sample 4 (4F): Front Boundary Only (Double Loop)

From the fence transmitter, run the wire to point **A**, then to point **B**. Make a U-turn and follow your path back to point **A**, keeping the wire separated by at least 5 ft. Then twist the wires from point **A** and connect them back to the fence transmitter.

Sample 5 (4G): Waterfront Property (Double Loop)

From the fence transmitter, run the wire to point **A**, then to point **B**. Make a U-turn and follow your path to **C**, then to **D**, then to **E**. Next, make another U-turn and follow the same path all the way back to point **A**, keeping the wire separated by at least 5 ft. Finally, twist the wires from point **A** and connect them back to the fence transmitter.

Sample 6 (4H): Wire Loop Attached to Existing Fence (Double Loop)

This layout allows you to include your existing fence as part of your layout and keep your pet from jumping out or digging under your existing fence. It reduces the amount of wire which will need to be buried. From the fence transmitter run the wire to point **A**, then to point **B** and so on (**B** to **C** to **D** to **E** to **F**). Next, make a U-turn and follow your path all the way back to point **A**, keeping the wire separated by at least 5 ft. Finally, twist the wires from point **A** back to the fence transmitter.

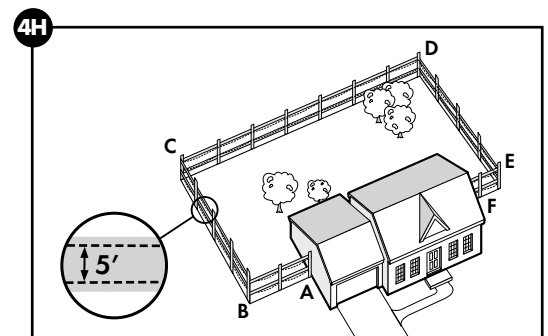
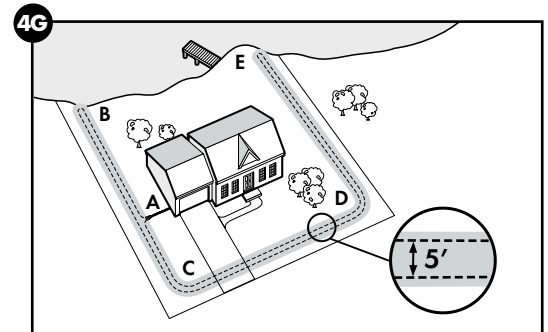
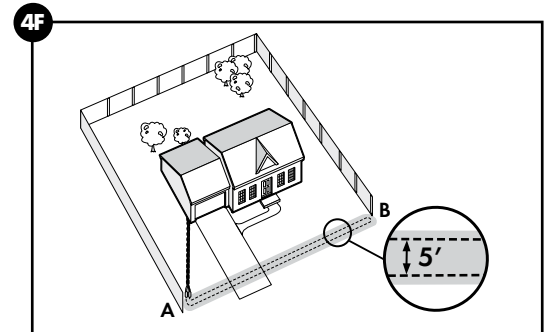
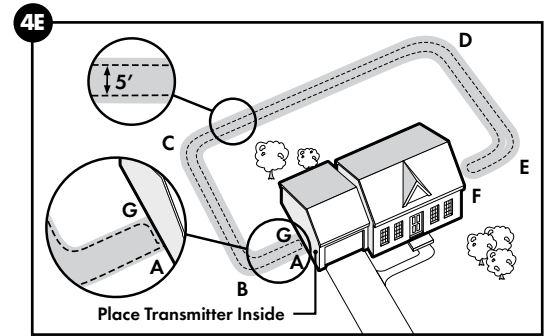

Step 5: Position, Twist and Splice the Boundary Wire

Once you have designed your layout, the next step is to position the wire along your property. Hold off on burying the wire until you have tested the system first.

1. Start with one end of the wire at the surge protector, but do not plug it in yet. Run the wire outdoors all the way around your planned perimeter and back to the surge protector.
2. You will need to twist the 2 wires together for the area running from the transmitter inside your home out to the yard so that your pet can cross this section without a correction (**5A**). Twisting both ends of the wire together 10–12 times per ft. cancels the signal. Keep in mind that crossover areas will only work when set up within the containment area. Straight crossover breaks along the perimeter, such as across driveways (**5B**), cannot be created and the signal will not be canceled.

Quick tip: The fastest way to twist 2 wires is to cut 2 pieces a little longer than the length you need, twist them and then “splice” in that section. Anchor one end of the 2 wires to something secure (or have a partner hold them), and insert the other end into a power drill. Pull the wire taut. Then use the drill to twist the wire quickly. Go slowly. Follow the splicing guide below to learn how to reconnect this twisted portion back to the main boundary wire.

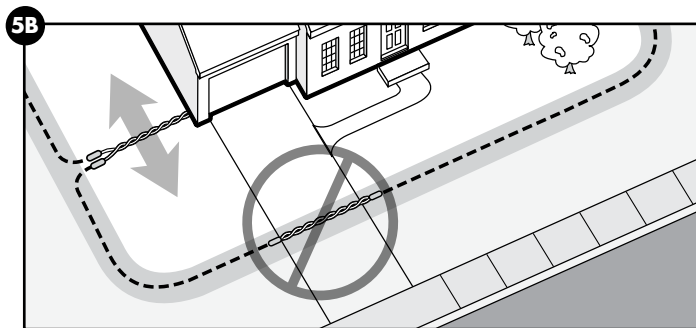
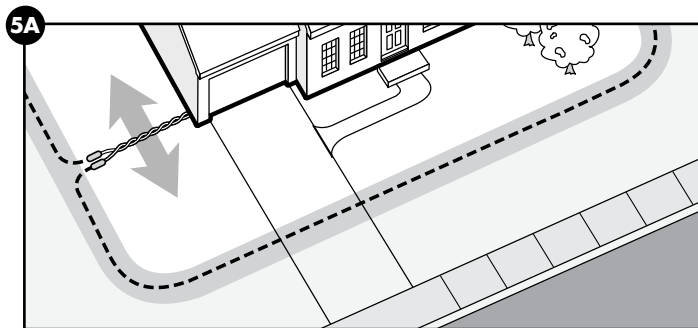

Splicing Guide

Although not required, it is recommended that you cut and splice the wire between each twisted section. Your Rechargeable In-Ground Fence™ system comes with 2 gel-filled splice capsules to ensure that your splices are waterproof. You can give us a call if you would like to purchase more splice capsules.

- a. Strip approximately $\frac{3}{8}$ in. of insulation off the ends of the wires to be spliced (**5C**).
- b. Insert the stripped ends into the wire nut and twist the wire nut around the wires. Make sure there is no copper exposed beyond the end of the wire nut.
- c. Tie a knot 3 to 4 in. from the wire nut (**5D**). Ensure that the wire nut is secure on the wire splice.
- d. Once you have securely spliced the wires together, open the lid of the gel-filled splice capsule and insert the wire nut as deeply as possible into the waterproof gel inside the capsule (**5E**).
- e. Snap the lid of the capsule shut (**5F**).

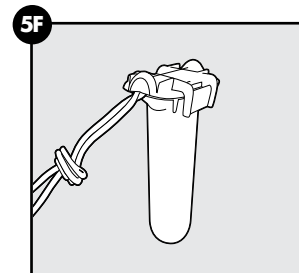
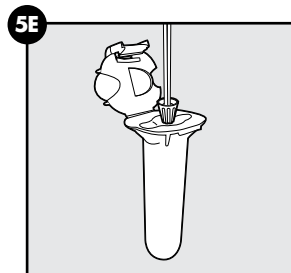
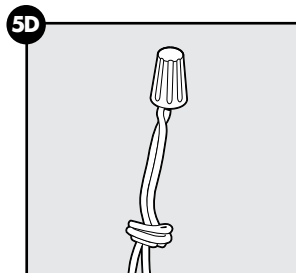
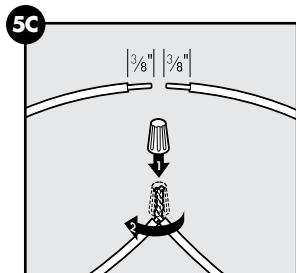

Additional Boundary Wire

Extra spools of boundary wire can be purchased in lengths of 500 ft. per spool where you purchased the kit or through the Customer Care Center.

Note: When adding boundary wire, it must act as a continuous loop.

The table on the right indicates the approximate length of boundary wire needed for a square, single loop layout. The length will vary due to the amount of twisted wire and the layout used.

Acres	Feet of Wire Needed	Number of Spools Needed
1/4	415	1
1/3	480	1
1/2	590	2
1	835	2
2	1180	3
5	1870	4
10	2800	6
25	4500	9

Step 6: Connect the Wires

Now that the boundary wire has been positioned and spliced, the next step is to connect the wire from inside to the surge protector, and then to the transmitter.

1. Strip $\frac{3}{8}$ in. of insulation from the 2 ends of the boundary wires in order to connect them to the surge protector (**6A**).
2. Insert the stripped ends into the 2 left red connector holes on the bottom of the surge protector labeled "LOOP" (**6B**). Make sure the copper ends do not touch each other at the terminals.
3. Next, connect the surge protector to the fence transmitter with 2 twisted wires. Measure and cut 2 lengths of wire, then strip $\frac{3}{8}$ in. of insulation at both ends from each. Twist the 2 lengths together, with at least 10–12 twists per ft., so the wires will not send out a signal.
4. Insert the 2 ends of the wires into the 2 black connectors at the bottom of the surge protector labeled "TRANSMITTER."
5. Next, insert the opposite ends of the twisted wire into the 2 red tabs on the fence transmitter.
6. Turn the boundary width control knob to 10. This will set the boundary width at the maximum width.
7. Plug the fence transmitter adapter into the outlet on the surge protector. You are now all connected (**6C**).
8. The power light and loop indicator light should come on. If this does not happen, check out our troubleshooting section, watch one of our instructional videos or give us a call.

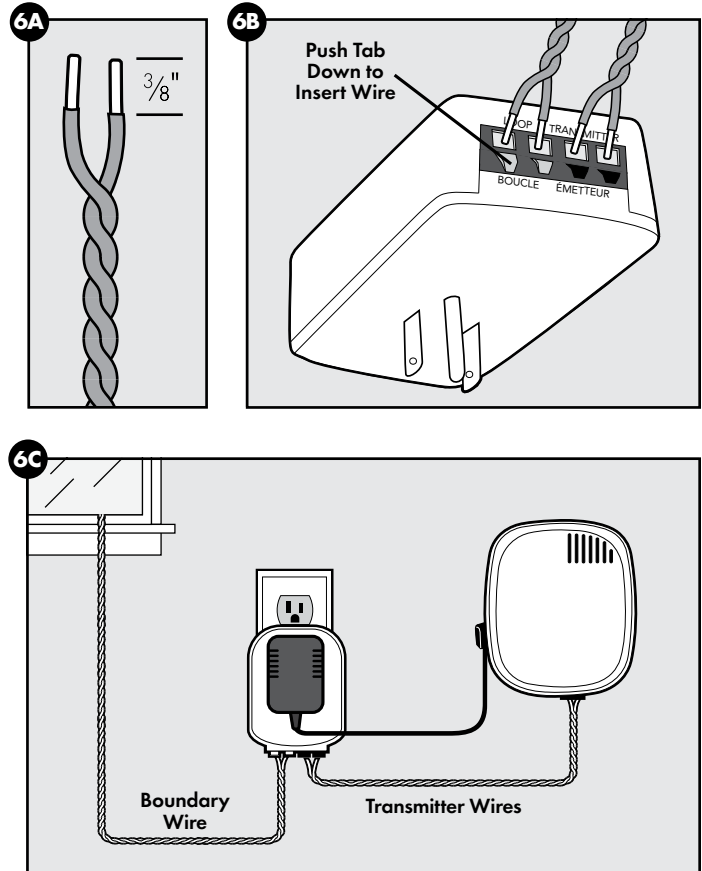

NOTICE

Verify that the boundary loop and transmitter wires are connected to the proper surge protector terminals. Reversed connections will result in an increased risk of surge-related damage.

NOTICE

For added protection, when unused for long periods of time or prior to thunderstorms, unplug from the wall outlet and disconnect the loop boundary wires. This will prevent damage to the transmitter due to surges.

Transmitter Setup (Australia and New Zealand)

1. Run the boundary wire through a window, under a door, through a crawl space vent or any other appropriate available access. You can also drill a hole through your wall.
2. Strip $\frac{3}{8}$ inch of insulation from the ends of the boundary wire.
3. Press the red tabs on the fence transmitter and insert the twisted wire into the boundary wire terminals. Make sure wires do not touch each other at the terminals.
4. Turn the boundary width control knob to 10. This will set the boundary width at the maximum width.
5. Plug the power adapter into the power jack and AC power outlet.
6. The power light and loop indicator light should come on. If this does not happen, check out our troubleshooting section, watch one of our instructional videos or give us a call.

⚠ WARNING

- Do not install, connect, or remove your system during a lightning storm. If the storm is close enough for you to hear thunder, it is close enough to create hazardous surges.
- Risk of electric shock. Use the fence transmitter indoors in dry location only.

CAUTION

If possible, DO NOT use an AC circuit protected with a Ground Fault Circuit Interrupter (GFCI) or Residual Current Device (RCD). In rare cases, nearby lightning strikes may cause the GFCI or RCD to trip. Without power your dog may be vulnerable to escape. You will have to reset the GFCI or RCD to restore power to the system.

NOTICE

For added protection, when unused for long periods of time or prior to thunderstorms, unplug from the wall outlet and disconnect the loop boundary wires. This will prevent damage to the transmitter due to surges.

Step 7: Prepare the Receiver Collar

In order to test the system you will need to use the receiver collar. Your receiver collar comes installed with short contact points. If your pet has long or thick hair, use the long contact points instead. Tighten or switch the contact points by using the contact point wrench (7A).

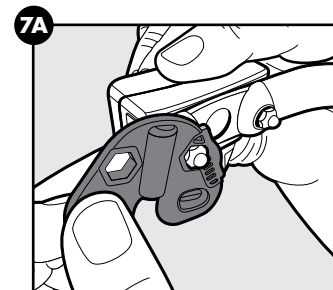

Turn the Receiver Collar On

To turn on the receiver collar, press and hold the mode button continuously for 5 seconds (7B). The receiver indicator light will turn on for 5 seconds to indicate battery status (green, yellow or red), followed by a series of red flashes which represent the static correction level.

Turn the Receiver Collar Off

To turn off the receiver collar, press and hold the mode button continuously for 5 seconds (7B). The red receiver indicator light will be on during this time. The red receiver indicator light will then turn off and all receiver indicator lights will stay off indicating that the unit is turned off. To extend the time between charging the receiver collar, consider turning off the receiver collar when it is not in use.

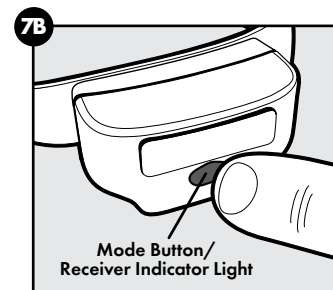

Receiver Collar Status Indicators

The receiver collar status indicator light, along with the receiver collar alarm tone, are used to determine the battery status and the correction type. Refer to the receiver collar status indicator table below to understand the status lights and tones for the receiver collar.

During normal operation, the receiver collar indicator light will flash every 4–5 seconds to indicate the battery status as shown in the following table.

Receiver Collar Status Indicator Table		
Status Light	Alarm Tone	Condition
While Plugged into the Receiver Charger		
Solid red	No tone	Charge in progress
Solid green	No tone	Charge complete
No light	–	Charge failure, contact Customer Care Center
After Removing from the Receiver Charger		
Continuous green, yellow or red (5 seconds duration)	No tone	Battery charge indication. Occurs immediately after unplugging the charger from the receiver collar
Operating Battery Status		
Slow blinking green (every 4–5 seconds)	No tone	Collar battery charge 100%–60%
Slow blinking yellow (every 4–5 seconds)	No tone	Collar battery charge 60%–20%
Slow blinking red (every 4–5 seconds)	No tone	Collar battery charge 20% or less, charge immediately
Receiver Activation Status		
Fast pulsating green (3 flashes per second)	Warning tone	Warning tone
Fast pulsating red (3 flashes per second)	Tone for duration of static correction	Static correction being delivered up to 15 seconds
Continuous green (10 seconds)	No tone	Over Correction Protection; collar locked for 10 seconds

Set the Static Correction Level

The static correction levels increase in strength from 2 to 5, with level 1 being tone only (no correction), and level 5 being the maximum setting. Refer to the table below to choose the static correction that best fits your pet.

1. Press and hold the mode button (**7B**) until the receiver collar illuminates a red light.
2. The receiver collar will then emit a series of red flashes representing the static correction level (e.g., 4 red flashes means level 4). You must count the number of red flashes to determine the level setting.
3. Increase the static correction level by pressing and holding the mode button for 1 second after each series of flashes.

Note: Once you count 5 red flashes you are at level 5, and an additional hold will cycle the receiver collar back to level 1, which is tone only.

Static Correction Level Table		
Indicator Light	Static Correction Level	Static Correction
1	1 red flash	None—tone only
2	2 red flashes	Low
3	3 red flashes	Medium
4	4 red flashes	Medium-high
5	5 red flashes	High

Anti-Linger Prevention

The Anti-Linger Prevention feature keeps your dog from staying in the warning zone for long periods of time and draining the receiver collar battery. Your dog will hear a warning tone when he reaches the warning zone. If your dog does not return to the pet area after 2 seconds, he will receive a continuous static correction until he returns to the pet area.

Run Through Prevention

This system includes a unique Run Through Prevention feature so that your dog cannot “run through” the pet area without receiving an increased level of static correction. The receiver collar automatically increases the static correction when your dog continues more than 20% of the way through the pet fencing boundary width. For example, if the signal is detected 10 ft. from the wire and your dog enters the static correction zone, this feature is activated when he is approximately 8 ft. from the boundary wire. Your dog will then receive a static correction that is at an increased level corresponding to the static correction level setting on the receiver collar. The receiver collar is equipped to automatically increase the level of static correction the longer your pet remains in the static correction zone if the collar is set at level 2 or above. The Run Through Prevention sound is an intermittent tone.

Over Correction Protection

In the unlikely event that your pet “freezes” in the static correction zone, this feature limits the static correction duration to a maximum of 15 seconds. After 15 seconds, the static correction will stop and the green indicator light will stay on for 10 seconds. The receiver collar remains locked out until your pet leaves the static correction zone.

Step 8: Set the Boundary Width and Test the Receiver Collar

With the boundary wire in place and properly connected, and the receiver collar fully charged, it is time to set the boundary width and test the system.

CAUTION The receiver collar should not be on your dog when the system is tested.

Note: The receiver collar is waterproof, which can make the tone hard to hear.

The flashing test light, when held to the contact points, indicates that the receiver collar is delivering static correction. To best utilize the automatic Run Through Prevention feature, the containment boundary width should extend at least 6 to 10 ft. on each side of the boundary wire (total boundary width of 12 to 20 ft.).

1. Apply power to the fence transmitter with the supplied power adapter.
2. Set the boundary width control switch (located on the side of the fence transmitter) (8A) to setting A, B, or C, based on the total length of boundary wire used. Setting B is used for most properties. Refer to the table to the right for the proper setting for your yard.
3. The boundary width is adjusted by using the transmitter's boundary width control knob (8B). Turn the knob counterclockwise until the alarm sounds and the loop indicator light is no longer lit. Turn the knob clockwise and increase by 2 numbers. The alarm should turn off and the light should turn on.

Setting	Amount of Wire Used
A	Greater than 2400 ft.
B	Up to 1300 ft.
C	1300 to 2400 ft.

CAUTION The receiver collar should not be on your dog when the system is tested. Your pet may receive an unintended correction.

4. To identify the warning and static correction zones make sure the static correction on the receiver collar is set at level 5 (see Step 7).
5. Test the boundary width of the system by selecting a section of straight boundary wire that is at least 50 ft. long. Start inside the center of the pet area.
6. Place the test light tool contacts against the receiver collar contact points (8C). Hold the receiver collar at your dog's neck height with the contact points pointing up. Slowly walk toward the boundary wire until you hear the warning tone (8D). When you hear the warning tone, you have identified the boundary width distance (static correction zone). Two seconds after the warning tone, the test light will begin to flash. This flashing light can aid you in identifying the boundary width if you have difficulty hearing the tone.

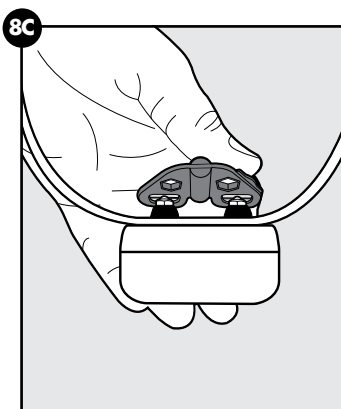
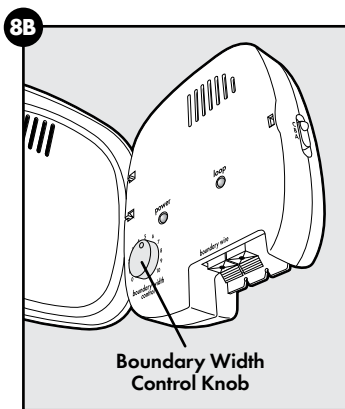
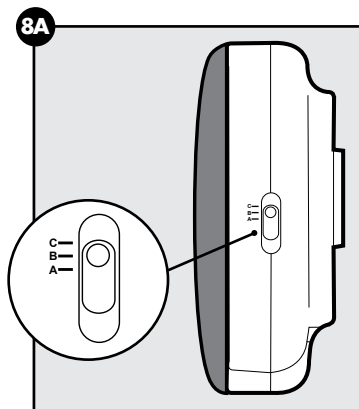

7. To prevent the receiver collar from going into Over Correction Protection mode, walk back into the pet area until the toning stops. If the receiver collar does not tone at the desired range, adjust the boundary width control knob to obtain the desired range. Turning the boundary width control knob clockwise increases the boundary width while turning it counterclockwise decreases it (**8E**). Repeat this activity as needed until the receiver collar tones between 6 to 10 ft. from the boundary wire. If using a double loop layout, you may need to increase the separation of the boundary wire and/or increase the size of the boundary width to achieve the desired range.
8. Test the boundary width in a number of different locations around the pet area until you are satisfied that the system is functioning properly.
9. Next, walk all around the pet area (**8F**) to ensure there are no areas where the receiver collar may activate from signals coupled onto buried wires or cables. Test the collar in and around the inside of the house as well. As mentioned, cable and wires from cable TV, electrical or telephone lines may conduct pet fencing signals inside and outside the house that can activate the dog's collar accidentally. While rare, if this occurs, your boundary wire is probably too close to these outside lines and should be moved or modified as shown in figure 1A.
10. To test the Run Through Prevention feature, walk towards the boundary wire. The receiver collar should tone and the test light should flash brighter as you enter the run through area (**8G**). If you are satisfied that your system is functioning properly, you are ready to start burying the boundary wire. If the receiver collar did not tone or the test light did not flash, see the troubleshooting section.

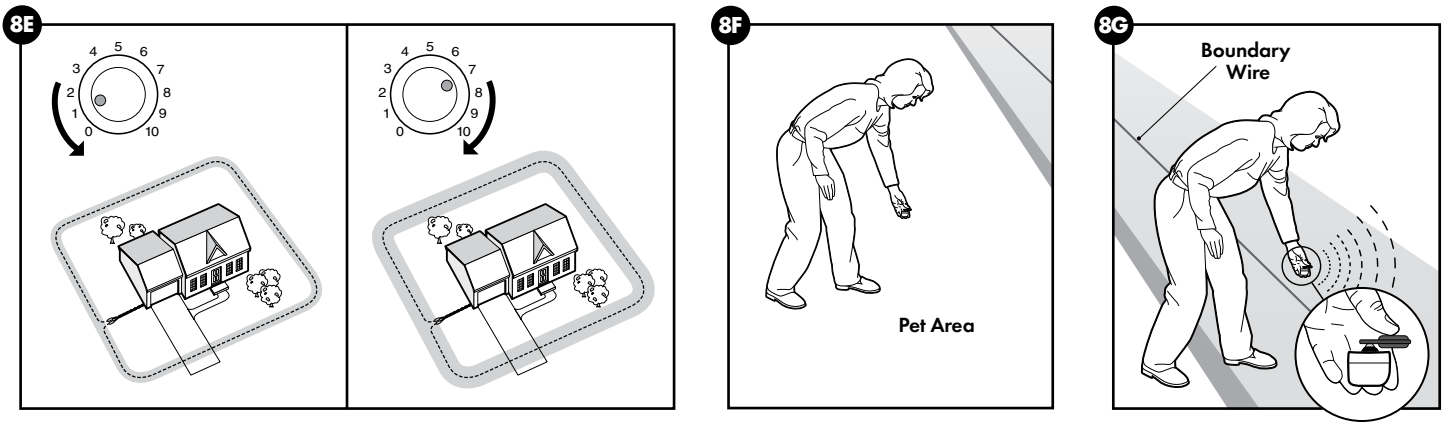

Step 9: Bury the Boundary Wire

⚠ WARNING

- Underground cables can carry high voltage. Have all underground cables marked before you dig to bury your wire. In most areas, this is a free service. Avoid these cables when you dig.
- Before you begin installing the boundary wire, turn the fence transmitter off and unplug the adapter from the surge protector.

Burying the boundary wire is recommended to protect it and prevent disabling the system.

1. Cut a trench 1–3 inches deep along your planned boundary. It only needs to be as wide as the wire.

Quick Tip: We have tried lots of tools. Lawn trenchers, which you can often rent from a local hardware store, work great and make for a quick job. You can also use a flat shovel, like a trenching shovel.

2. Place the boundary wire into the trench maintaining some slack to allow it to expand and contract with temperature variations.
3. Use a blunt tool such as a wooden paint stick to push the boundary wire into the trench. Be careful not to damage the boundary wire insulation.

Utilizing an Existing Fence

The boundary wire can be attached to a chain link fence, split rail fence or a wooden privacy fence. The boundary wire can be attached as high as needed. However, make sure the boundary width is set at a high enough range for your pet to receive the signal. If using a double loop with an existing fence at least 5 ft. tall, run the boundary wire on top of the fence and return it on the bottom of the fence to get the 5 ft. separation needed.

- **Chain Link Fence (9A):**

Weave the boundary wire through the links or use plastic quick ties.

- **Wooden Split Rail or Privacy Fence (9A):**

Use staples to attach the boundary wire. Avoid puncturing the insulation of the boundary wire.

- **Double Loop with an Existing Fence:**

Run the boundary wire on top of the fence and return it on the bottom of the fence to get the 5 ft. separation needed.

- **Gate (Single Loop) (9B):**

Bury the boundary wire in the ground across the gate opening.

Note: The signal is still active across the gate. Your pet cannot pass through an open gate.

- **Gate (Double Loop) (9B):**

Bury both boundary wires across the gate opening while keeping them 5 ft. apart.

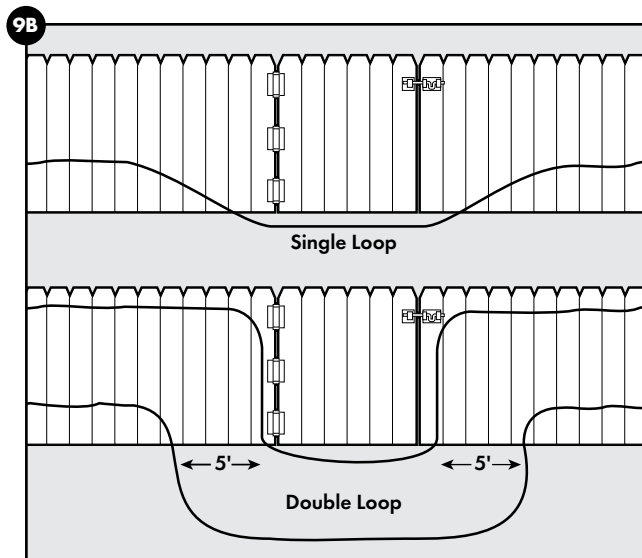
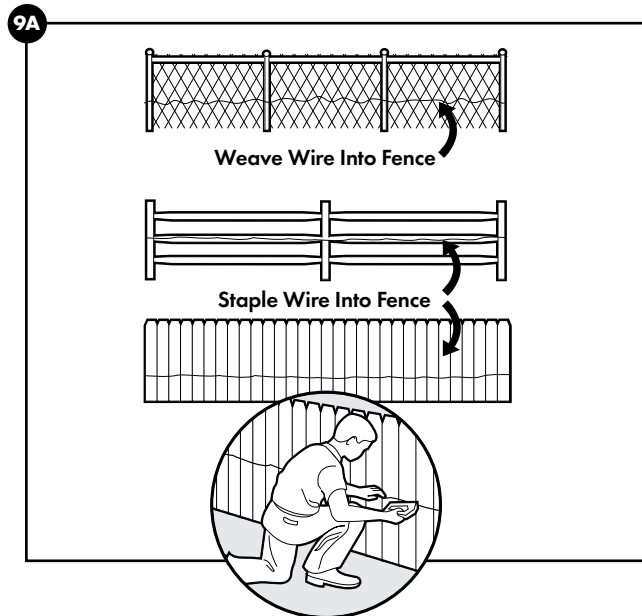

⚠ WARNING

Follow all safety instructions for your power tools. Be sure to always wear your safety goggles.

Cross Hard Surfaces (driveways, sidewalks, etc.)

- **Concrete Driveway or Sidewalk (9C):** Place the boundary wire in a convenient expansion joint or create a groove using a circular saw and masonry blade. Place the boundary wire in the groove and cover with an appropriate waterproofing compound. For best results, brush away dirt or other debris before patching.
- **Gravel or Dirt Driveway (9D):** Place the boundary wire in a PVC pipe or water hose to protect the boundary wire before burying.

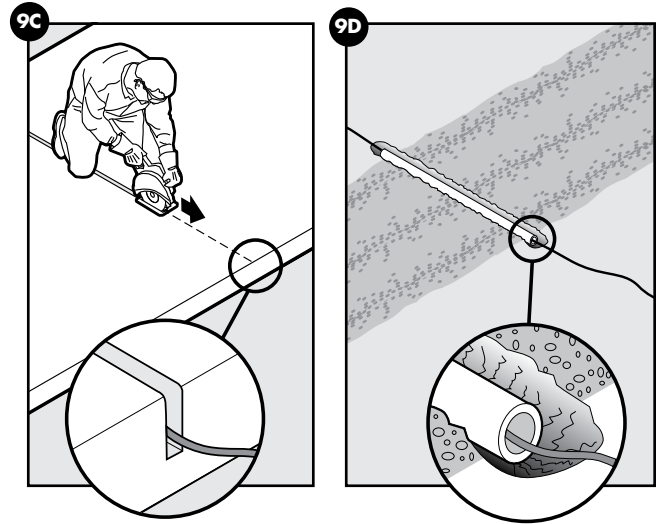
**Step 10: Place the Boundary Flags**

The boundary flags are visual reminders for your pet of where the warning zone is located.

1. Place the test light contacts on the contact points. Hold the receiver collar at the height of your pet's neck (10A).
2. Walk towards the warning zone until the receiver collar beeps (10B).
3. Place the boundary flag in the ground along the boundary wire (10C).
4. Walk back into the pet area until the beeping stops.
5. Repeat this process along the warning zone until it is marked with boundary flags every 10 ft. (10D).

Note: If you cannot hear the beep, refer to the test light instructions in Step 8.

CAUTION

To prevent an unintended correction, after the boundary flags have been placed, be sure to set the static correction on the receiver collar back to level 1, which is tone only.

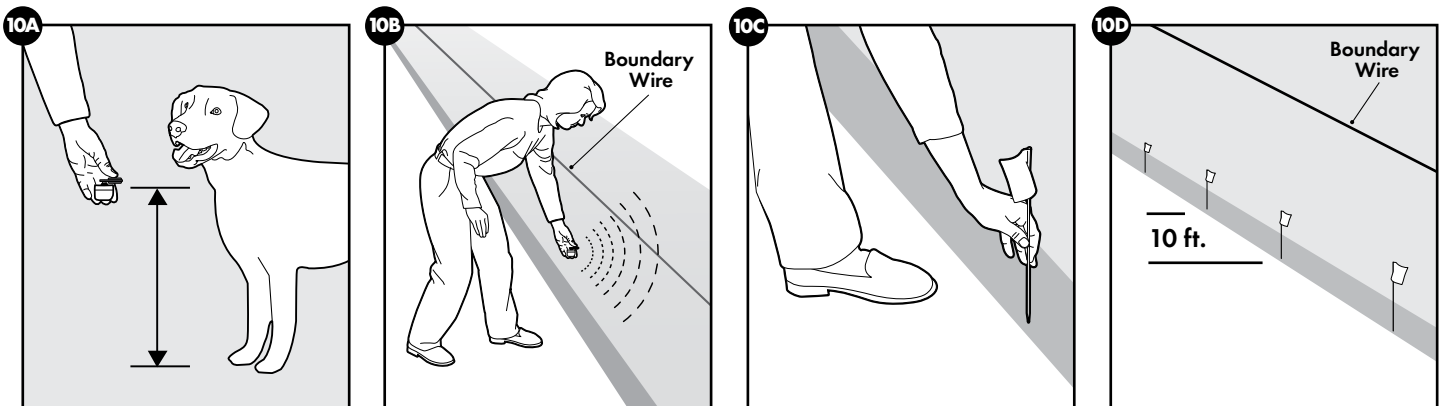

Step 11: Fit the Receiver Collar

CAUTION

Proper fit of the receiver collar is important. A receiver collar worn for too long or made too tight on your pet's neck may cause skin damage, ranging from redness to pressure ulcers. This condition is commonly known as bed sores.

- **Avoid leaving the receiver collar on your pet for more than 12 hours per day.**
- When possible, reposition the receiver collar on your pet's neck every 1 to 2 hours.
- Check the fit to prevent excessive pressure; follow the instructions in this manual.
- Never connect a leash to the receiver collar; it will cause excessive pressure on the contact points.
- When using a separate collar for a leash, do not put pressure on the receiver collar.
- Wash your pet's neck area and the contact points of the receiver collar weekly with a damp cloth.
- Examine the contact area daily for signs of a rash or a sore.
- If a rash or sore is found, discontinue use of the receiver collar until the skin has healed.
- If the condition persists beyond 48 hours, see your veterinarian.
- For additional information on bed sores and pressure necrosis, please visit our website.

These steps will help keep your pet secure and comfortable. Millions of pets are comfortable while they wear stainless steel contact points. Some pets are sensitive to contact pressure. You may find after some time that your pet is very tolerant of the receiver collar. If so, you may relax some of these precautions. It is important to continue daily checks of the contact area. If redness or sores are found, discontinue use until the skin has fully healed.

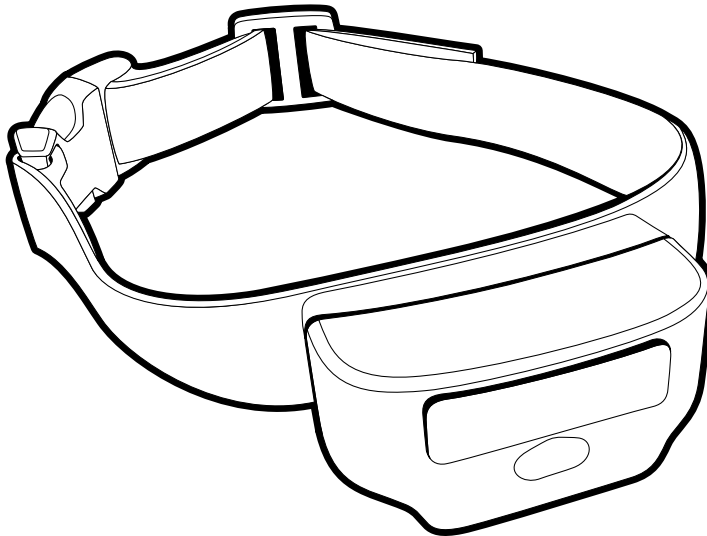

Important: The proper fit and placement of your receiver collar is important for effective training. The contact points must have direct contact with your pet's skin on the underside of his neck.

1. Be sure the receiver collar is off before placing it on your pet. Then with your pet standing (**11A**), fit the receiver collar snugly onto your pet's neck so that the contact points make contact with your pet's skin on the underside of his or her neck.
2. Check the tightness of the receiver collar by inserting one finger between the end of a contact point and your pet's neck. The fit should be snug but not constricting (**11B**).

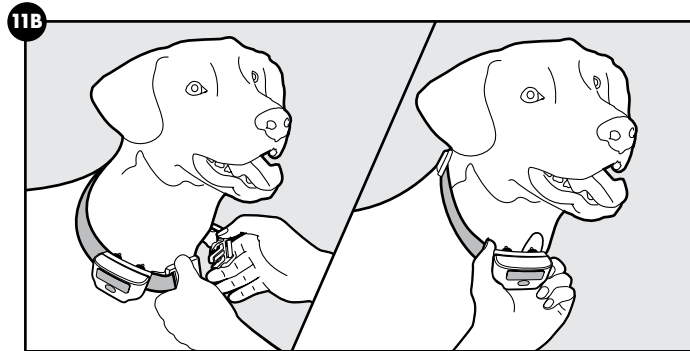
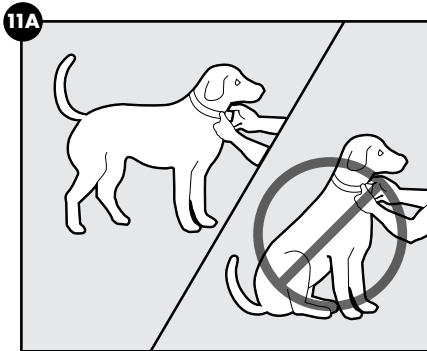

CAUTION You may need to trim the hair in the area of the contact points. Never shave your pet's neck; this may lead to a rash or infection.

3. Allow your pet to wear the receiver collar for a few minutes, then check it again.
4. Once you are satisfied with the fit of the receiver collar, remove it from your pet and trim it, but make sure to allow room for growth or a thicker winter coat. Use a lighter to seal the cut so that it will not fray (**11C**).
5. The collar will slip if it is not properly threaded. The slide buckle prevents the collar from becoming loose around your pet's neck and the ridges must be facing up (**11D**).

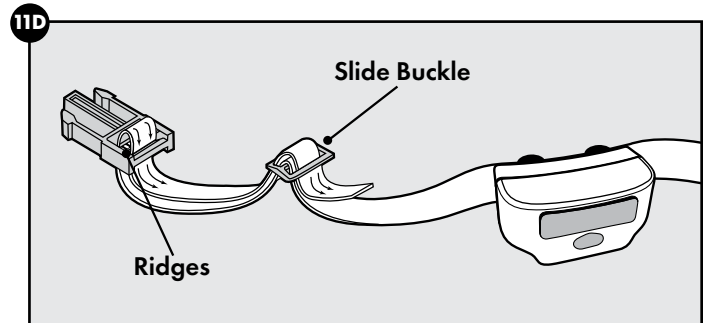
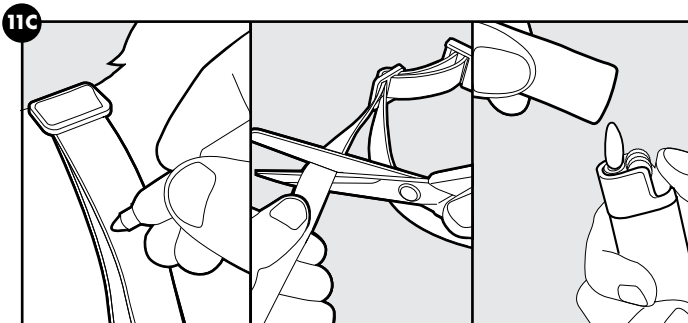

Training Guide

Important: Proper training of your pet is essential to the success of the Petsafe® Rechargeable In-Ground Fence™ system. Read this section completely before beginning to train your pet. Remember that this PetSafe Rechargeable In-Ground Fence system is not a solid barrier.

- Pets respond to our emotions. You should stay upbeat and have fun with your pet throughout the training process.
- Train for 15 minutes or less at a time. Do not try to do too much too quickly. More-frequent short sessions are better than less-frequent longer sessions.
- We suggest a minimum of 14 days of training. Depending on your pet and your consistency, the training could take more or less time.
- Always have small pieces of your pet's favorite treats readily at hand. Promptly reward your pet for good behavior. If your pet goes crazy for a certain ball or toy, use that instead or in addition. Never treat your pet or allow them to eat a treat in the static correction zone.
- If your pet shows signs of stress, slow down the training schedule, add additional days of training or increase the amount of play time with your pet in the pet area. Common stress signals include:
 - Pet pulling on leash toward the house
 - Ears tucked or pulled back
 - Tail down or tucked between legs
 - Body lowered
 - Nervous/frantic movement or stiffening of pet's body
 - Lip-licking or yawning
- Your pet must be completely comfortable near the boundary flags at the end of every training session. Spend at least 5 minutes of "play time" at the completion of each session within 10 ft. of the boundary flags.
- Finish each training session on a positive note with lots of praise and play.
- Remove the receiver collar after each training session.
- Be sure to contain your pet by another means during the training period (e.g. pen, tie-out, leash, etc.). If you need to take your pet out of the pet area, remove the receiver collar and either pick your pet up or put him in the car to pass out of the pet area. The goal is for your pet to associate leaving the pet area only with you.
- Even if you think your pet is responding well to the training, complete the entire training. Consistency is key.

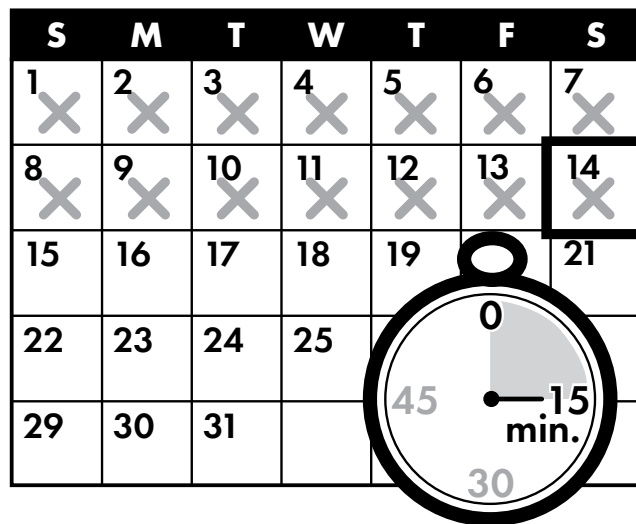

Phase 1

Day 1—Tone-only Training for Boundary Awareness

Perform 3 training sessions per day, each lasting 10–15 minutes.

Goal:

To have your pet learn that the boundary flags and warning tone from the receiver collar define the new pet area.

Setup:

- Program the static correction level on the receiver collar to level 1, which is tone-only training mode.
- Put a separate non-metallic collar on your pet's neck below the receiver collar and attach a leash.

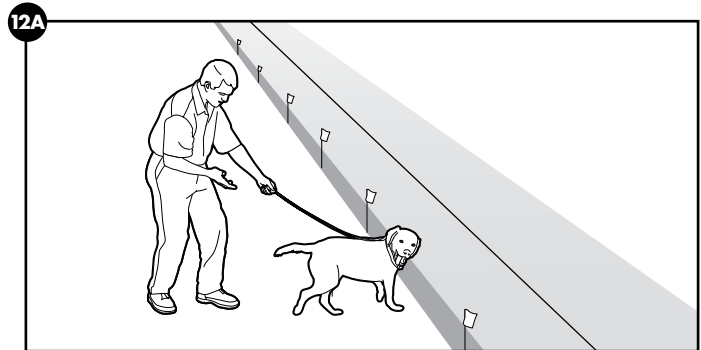

CAUTION Be sure the extra collar does not put pressure on the contact points.

- Have small pieces of your pet's favorite treats available.
- Have your pet's favorite play toy available.

Steps:

1. Begin by walking your pet on a leash in the pet area. Calmly praise and talk to your pet.
2. Move toward the boundary flags (12A). Your pet reads your energy so keep your mood happy.
3. With full control of your pet on a leash, walk past the flags (12B). Allow your pet to stay in the static correction zone for up to 2 seconds then gently help him or her back into the pet area (12C). Immediately praise and offer your pet a treat as he or she enters the pet area, even if you have helped with the leash.

Note: Pulling on the leash is not as effective as encouraging your pet to come when called.

4. Repeat this process at the same boundary flag until your pet resists going into the static correction zone.
5. Aim to master 3–4 boundary flags per session. Make this FUN! Praise your pet if he or she quickly retreats or resists going into the static correction zone. **Note:** Never treat your pet or allow them to eat a treat in the static correction zone.

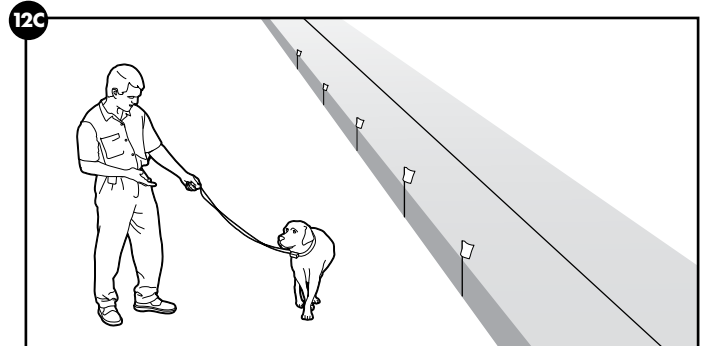
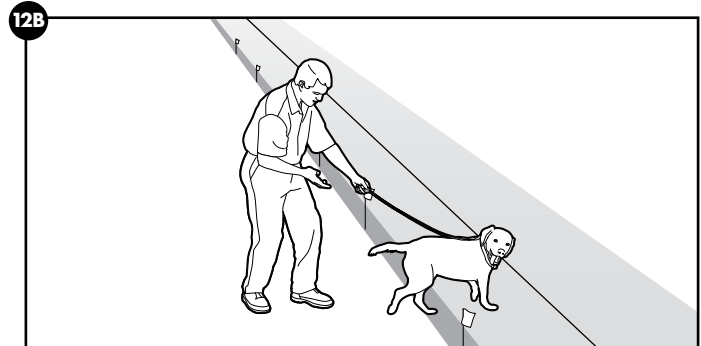

Phase 2

Days 2 Through 4—Boundary Awareness with Static Correction

Perform 3 training sessions per day, each lasting 10–15 minutes.

Goal:

To train your pet to stay in the pet area and respect the boundary.

Setup:

- Program the static correction level on the receiver collar to level 2.
- Put a separate non-metallic collar on your pet's neck below the receiver collar and attach a leash.

CAUTION Be sure the extra collar does not put pressure on the contact points.

- Have small pieces of your pet's favorite treats available.
- Have your pet's favorite play toy available.

Steps:

1. Repeat steps 1–3 in Phase 1, this time allowing your pet to stay in the correction zone long enough to be corrected.
2. Observe whether or not your pet seems to feel the correction. A slight change in your pet's behavior, such as looking around in curiosity, scratching at his collar or flicking his ears, indicates your pet's recognition level. If your pet does not respond to the static correction, confirm that the receiver collar is fitting properly according to Step 11 on page 23.
3. If the receiver collar is fitted properly and your pet does not respond to the static correction, increase the static correction level by one setting. Continue to observe whether your pet is looking around in curiosity, scratching at his collar or flicking his ears.
4. Stay at the same flag until your pet resists going into the static correction zone.

Phase 3

Days 5 Through 8—Distraction Phase

Perform 3 training sessions per day, each lasting 10–15 minutes.

Goal:

To train your pet to stay within the pet area with distractions outside of the pet area.

Setup:

- Program the static correction level on the receiver collar to level 2 or higher, depending on the reaction results from days 2 through 4.
- Put a separate non-metallic collar on your pet's neck below the receiver collar and attach a leash.

CAUTION Be sure the extra collar does not put pressure on the contact points.

- Have small pieces of your pet's favorite treats available.
- Have your pet's favorite play toy available.
- Stage some distractions to tempt your pet to enter the static correction zone. Start with temptations that are of lower value for your pet, and work your way up. It is typically harder for pets to resist temptations that are close by than those further away:
 - Have a family member cross from inside the pet area to outside of it.
 - Place a ball, treat or toy outside of the pet area.
 - Have a neighbor walk their pet outside of the pet area.
- Gradually increase distraction level.

Never coax or call your pet out of the pet area.

Steps:

1. With full control of your pet on a leash, have the distraction presented.
2. If your pet does not move toward the distraction, praise and offer a treat.
3. If your pet does react to the distraction, allow him or her to go into the static correction zone while still on the leash.
4. Help your pet back into the pet area if he or she does not turn back after 2 seconds.
5. Treat and praise your pet anytime he or she comes back into the pet area with or without help.
6. Repeat this process with other distractions. Use other family members during this process.
7. If your pet does not respond to the static correction, confirm that the receiver collar is fitting properly according to Step 11 on page 23.
8. If the receiver collar is fitted properly and if your pet does not respond to the static correction, increase the static correction level by one setting.

Phase 4

Days 9 Through 14—Unleashed Supervision

Training sessions should start at 10–15 minutes, gradually increasing to over an hour.

Your pet is ready for this step only when he or she clearly avoids the entire static correction zone, regardless of any distractions or temptations. During this step, do not leave your pet unattended.

Goal:

To give your pet free run of the pet area off the leash.

Setup:

- Adjust the static correction level to the permanent setting appropriate for your pet.
- Put a separate non-metallic collar on your pet's neck below the receiver collar. Keep a leash close by to use in case your pet escapes the pet area.

Steps:

1. Enter the pet area with your pet wearing the receiver collar.
2. Walk around the yard and play with your pet, staying within the pet area at all times (12D).
3. Preoccupy yourself with another task in the yard while watching your pet.
4. Should your pet escape, take the receiver collar off and lead him back into the pet area.

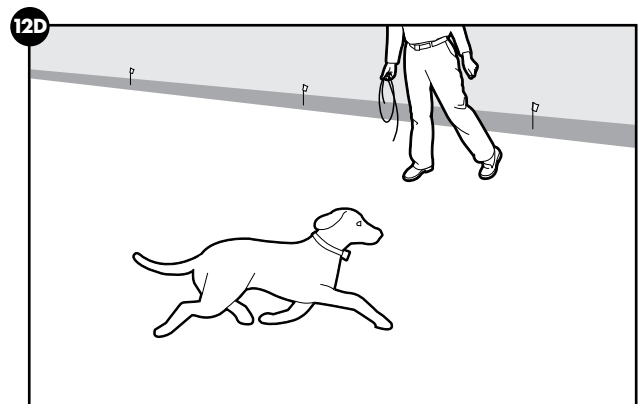

Phase 5

Days 15 Through 30—Pet Monitoring

Your pet is ready to run! Just make sure to check on your pet at regular intervals.

Note: After you are satisfied that your pet's training is complete, remove every other boundary flag every 4 days until all flags are removed. Save your boundary flags for future use.

Taking Your Pet Out of the Pet Area

Important: Remove the receiver collar and leave it at home.

Once your pet learns the boundary, he will be reluctant to cross it for walks or car rides.

Option 1:

Replace the receiver collar with a regular collar. Put your pet in a car that is within the pet area and drive him out of the pet area (12E).

Option 2:

Replace the receiver collar with a regular collar and leash. Walk your pet out of the pet area while giving a command such as "OK" at a specific place along the boundary (the end of your driveway, sidewalk, etc.). Always leave the pet area from the same spot in your yard with a leash and your pet will associate leaving the pet area only on a leash, only at this spot, and only with a person. You may initially need to convince your pet to leave the pet area with a treat and lots of praise.

Note: You may also carry your pet out of the pet area.

Congratulations! You have now completed the training program. You are both ready to enjoy more freedom. Just make sure to continue to check the tightness of the receiver collar and remove it when it is not in use.

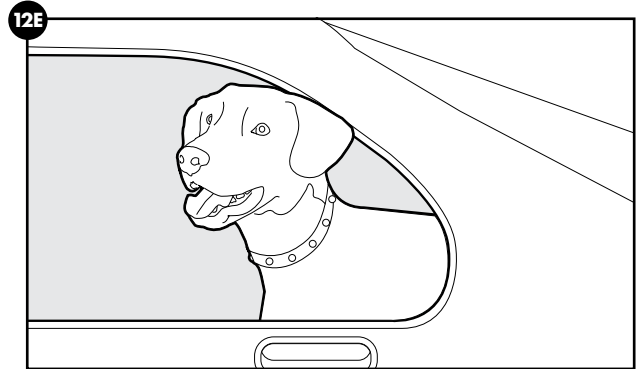

Accessories

To purchase additional accessories for your PetSafe® Rechargeable In-Ground Fence™ system, contact the Customer Care Center at 1-800-732-2677 or visit our website at www.petsafe.net to locate a retailer near you.

System Test

The system test is used to determine the cause of system problems that have not been addressed elsewhere in this guide. You will need a piece of boundary wire greater than 15 ft. long with $\frac{3}{8}$ in. of insulation removed from each end to use as a test loop wire. Make a note of your boundary width dial setting, and receiver collar setting before beginning the system test.

Follow the steps below to perform the system test:

1. Remove the receiver collar from your dog and make sure it is fully charged.
2. Set the boundary control switch to B.
3. Set the receiver collar static correction to level 5.
4. Disconnect the twisted boundary wire from the boundary wire terminals on the fence transmitter by pressing the red release levers on the connector and pulling the wires free **(13A)**.
5. Insert the two ends of the test loop wire into the boundary wire terminals on the transmitter.
6. Turn the boundary width control knob to 10 and then back to 5.
7. Place the test light tool contacts on the contact points of the receiver collar. While holding the receiver collar with the test light tool in place, approach the wire from the outside loop 2 inches off the ground. Make a mental note of the distance where the receiver collar activates from the wire.
8. Turn the boundary width control knob to 10 and repeat step 7. The distance where the receiver collar activates should be greater than the previous result.
9. If more than one receiver collar is used on the system, repeat the above test on each collar.
10. Keep the boundary width control knob position at 10. Set the boundary control switch to A. Then approach the loop with the receiver collar, as in step 7, and verify that the receiver collar activates.
11. Keep the boundary width control knob position at 10. This time set the boundary control switch to C. Approach the loop with the receiver collar, as in step 7, and verify that the receiver collar activates.
12. Interpreting the results:
 - a. If the power light or the loop indicator light are not both lit on the fence transmitter, or the alarm is on, for any of the above tests, there is a problem with the transmitter. Contact the Customer Care Center.
 - b. If both the power and loop indicator lights are on, but the receiver collar does not activate on the test loop wire, the receiver collar is not working. Contact the Customer Care Center.
 - c. If the transmitter power and loop indicator lights are on in each of the 3 boundary control switch positions and the receiver collar is activating at different distances on the test loop wire, the problem is most likely in the containment boundary wire or surge protector. Reconnect the transmitter wires to the surge protector and connect the test loop to the surge protector loop terminals **(13B)**. Repeat steps 6–11.

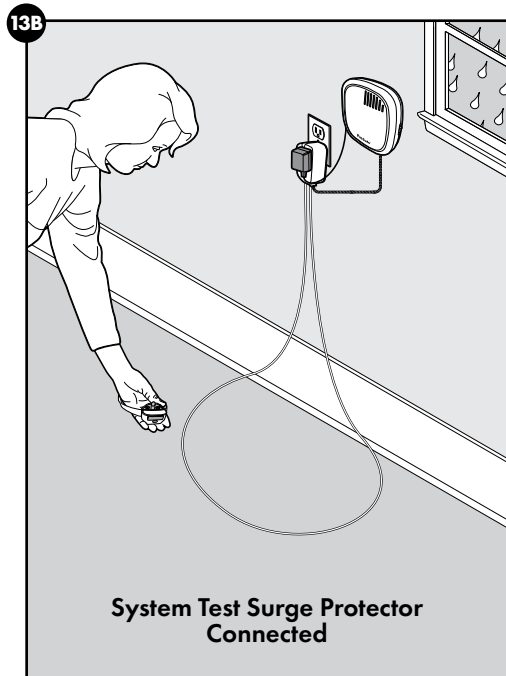
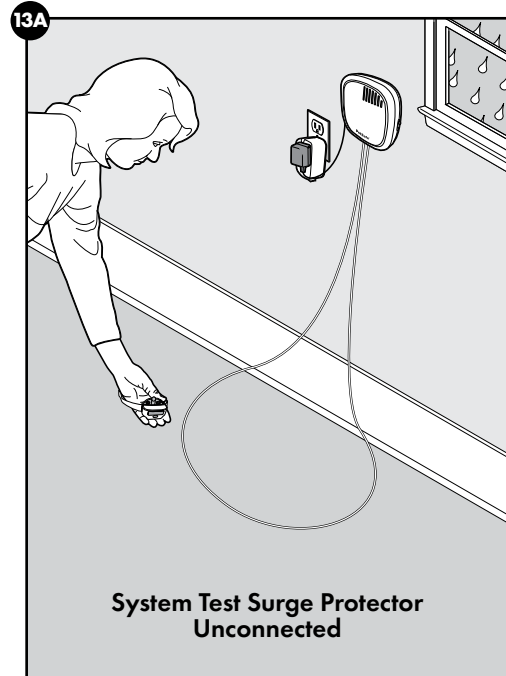

13. Interpreting the results with the surge protector:
 - a. If both the power and loop indicator lights are on and the receiver collar is activating at different distances on the test loop wire, the problem is in the containment boundary wire. Perform the wire break location test.
 - b. If the loop indicator light is off with an alarm on the fence transmitter, there is a problem with the surge protector. Contact the Customer Care Center.
 14. When the testing is complete, reconnect and verify that the boundary wire is plugged into the loop terminals on the surge protector and the transmitter is connected to the surge protector.
 15. Return the boundary control switch and the boundary width control knob setting to the position noted earlier.
 16. Repeat the boundary width testing from step 7 until you achieve the desired boundary width between 12 to 20 ft.
-

Wire Break Location Test

The following lists identify the common locations where wire breaks occur. Please inspect these areas for signs of damage.

Wire breaks in the twisted pair are commonly found:

1. At the wire exit point of the house
2. Where the twisted pair of wire enters the ground from the house, usually caused by string trimmers
3. Where the wires cross sidewalks or driveways due to edging and string trimmers
4. Around landscaping and flower beds due to digging, or working up the soil

Wire breaks in the boundary wire are commonly found:

1. In aerated lawns
2. Where the wires cross sidewalks or driveways due to edging and string trimmers
3. Around landscaping and flower beds due to digging, or working up the soil
4. At wire splices where gel-filled capsules have not been installed
5. At wire splices without reinforcement knots **(14A)**

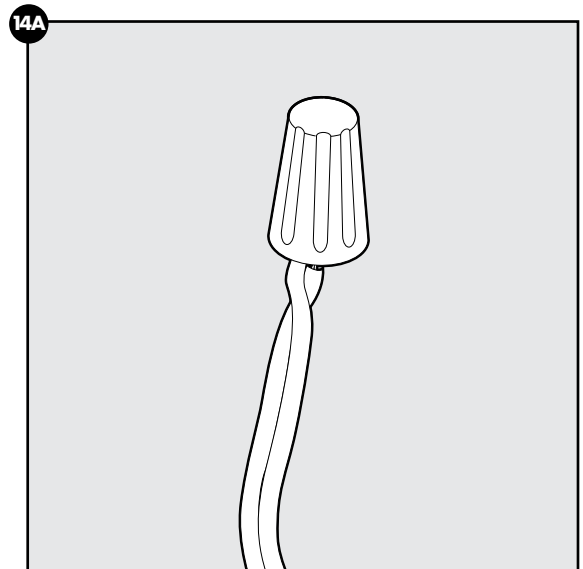

If you still cannot find the break in the boundary wire, there are 2 options for locating it:

Option 1: It is recommended to contact the Customer Care Center to purchase a wire break locator (RFA-450) (14B).

Option 2: Follow the procedure below:

1. Unplug the fence transmitter.
2. Connect both ends of your twisted boundary wire to one loop terminal on the surge protector.
3. Measure and cut a test wire which is half the length of your total boundary wire footage.
4. Connect one end of test wire to the other loop terminal on the surge protector.
5. Locate the halfway point of your boundary and cut the boundary wire.
6. Splice the other end of the test wire to either side of your boundary wire where you cut it in half.
7. Plug in the fence transmitter, set the mode to Traditional mode (B), and check the loop indicator light. If the loop indicator light is on, you can assume that the break is in the other half of the boundary wire.
8. If the loop indicator light did not come on, you may assume there is a break in this portion of the boundary wire. However, there is a small chance of having more than one break in your system. Be sure to check both halves of your entire loop.
9. Replace the damaged boundary wire with new boundary wire.
10. Reconnect the boundary wire to the surge protector.
11. Check the loop indicator light. If the loop indicator light is on, test the system with the receiver collar.

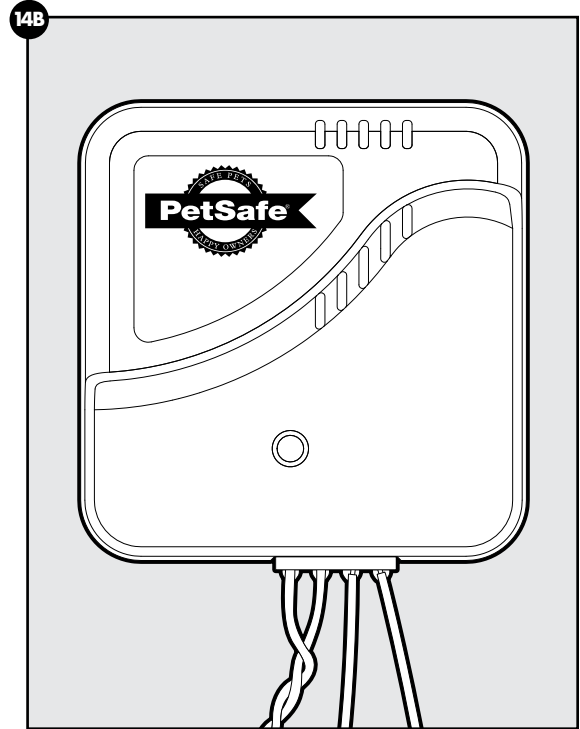

Troubleshooting

The receiver collar is not beeping or correcting.	<ul style="list-style-type: none">• Charge the receiver collar.• Make sure the receiver collar is turned on and the battery status lights are flashing every 4–5 seconds.• Check that both lights are lit on the fence transmitter. If not, perform the “System Test” on page 29.
The receiver collar is beeping, but the pet is not responding to the static correction.	<ul style="list-style-type: none">• Make sure the static correction is set at level 2 or above.• Test the receiver collar with the test light by walking toward the boundary wire. If the test light flashes, adjust the fit of the receiver collar.• Trim your pet’s fur where the contact points touch the neck and/or switch to the longer contact points.• The contact points must be in contact with dog’s skin.• Increase the static correction level.• Repeat the training steps to reinforce training.• Purchase a stronger receiver collar by contacting the Customer Care Center.
The receiver collar has to be held on top of the boundary wire to activate.	<ul style="list-style-type: none">• Charge the receiver collar.• Make sure the receiver collar is turned on and the battery status lights are flashing every 4–5 seconds.• Adjust the boundary width control knob clockwise to increase the distance from the boundary wire that the receiver collar activates. Verify that the boundary control switch is placed at the proper setting according to the amount of boundary wire used (see Step 8).• If using a double loop layout, make sure the boundary wires are separated at least 5 ft.• If the receiver collar still has to be held on top of the boundary wire, perform the “System Test” on page 29.
The receiver collar activates inside the house.	<ul style="list-style-type: none">• Turn the boundary width control knob counterclockwise to decrease the distance from the boundary wire that the receiver collar activates.• Make sure the boundary wire is not running within 15 ft. of the house. The signal can transmit through the walls of your house.• Make sure the boundary wires are twisted from the boundary to the fence transmitter.
I have an inconsistent signal.	<ul style="list-style-type: none">• Make sure the fence transmitter is at least 3 ft. from large metal objects or appliances.• Make sure all boundary wire turns are gradual with a minimum 3 ft. radius.• Make sure the boundary wire is not running parallel to or within 10 ft. of electrical wires, neighboring containment systems, telephone wires, television or antenna cables, or satellite dishes.• If a neighboring containment system may be causing an inconsistent signal, move the boundary wire farther away from the neighboring containment system.

<p>The power and loop indicator lights are off.</p>	<ul style="list-style-type: none"> • Check that the power adapter is plugged into the fence transmitter. • Check that the power adapter is plugged in properly. • If the system is plugged into a GFCI or RCD outlet, check to see if the circuit has been tripped. Reset the GFCI or RCD circuit if required. • Verify that the outlet is working properly by plugging in a known working item such as a radio. • Try plugging the fence transmitter into another 120-volt outlet. • If the lights still do not come on, the fence transmitter and/or power adapter needs to be replaced. Contact the Customer Care Center. • If a surge protector is installed, unplug the surge protector and plug the power adapter directly into the outlet. If the transmitter operates without the surge protector, contact the Customer Care Center for a replacement surge protector.
<p>The power light is on, the loop indicator light is off, and the fence transmitter loop alarm is sounding.</p>	<ul style="list-style-type: none"> • Check the boundary wire connections at the fence transmitter for proper connection. • Check for broken or damaged boundary wires at the outside entry to the house. • Perform the "System Test" (page 29) to determine if the fence transmitter or surge protector needs to be replaced. • If the fence transmitter is functioning properly, you have a break in your boundary wire. See the "Wire Break Location Test" section (page 30) in this guide.

Terms of Use and Limitation of Liability

1. Terms of Use

This Product is offered to you conditioned upon your acceptance without modification of the terms, conditions and notices contained herein. Usage of this Product implies acceptance of all such terms, conditions, and notices.

2. Proper Use

This Product is designed for use with pets where training is desired. The specific temperament of your pet may not work with this Product. If you are unsure whether this is appropriate for your pet, please consult your veterinarian or certified trainer.

3. No Unlawful or Prohibited Use

This Product is designed for use with pets only. This pet training device is not intended to harm, injure or provoke. Using this Product in a way that is not intended could result in violation of Federal, State or local laws.

4. Limitation of Liability

In no event shall Radio Systems Corporation be liable for any direct, indirect, punitive, incidental, special or consequential damages, or any damages whatsoever arising out of or connected with the use or misuse of this Product. Buyer assumes all risks and liability from the use of this Product.

5. Modification of Terms and Conditions

Radio Systems Corporation reserves the right to change the terms, conditions and notices under which this Product is offered.

Compliance

FCC/IC

This Class B digital apparatus complies with Canadian RSS-310. This equipment has been tested and found to comply with the limits for a Class B digital device, pursuant to Part 15 of the FCC Rules. These limits are designed to provide reasonable protection against harmful interference when the equipment is operated in a residential environment. This equipment generates, uses, and can radiate radio frequency energy and, if not installed and used in accordance with the instruction guide, may cause harmful interference to radio communications. However, there is no guarantee that interference will not occur in a practical installation. If this equipment causes harmful interference to radio or television reception, which can be determined by turning the equipment off and on, the user is encouraged to try to correct the interference by one or more of the following measures:

- Relocate the interfered receiving antenna.
- Increase the separation between the equipment and receiver.
- Connect the equipment into an outlet on a circuit different to that to which the receiver is connected.
- Contact the Customer Care Center at 1-800-732-2677.

This device complies with Industry Canada Rules. This device complies with part 15 of the FCC Rules. Operation is subject to the following two conditions: (1) This device may not cause harmful interference, and (2) this device must accept any interference received, including interference that may cause undesired operation.

Unauthorized changes or modifications to the equipment, not approved by Radio Systems Corporation, could result in not meeting compliance with FCC regulations and could void the user's authority to operate the equipment.

ACMA/Australia

This device complies with the applicable EMC requirements specified by the ACMA (Australian Communications and Media Authority).

Customer Care International

USA & Canada—Tel: 800-732-2677

Monday–Friday 8 AM – 8 PM / Saturday 9 AM – 5 PM

Australia—Tel: 1800 786 608

Monday–Friday 8:30 AM – 5 PM

New Zealand—Tel: 0800 543 054

Monday–Friday 10:30 AM – 7 PM



Battery Disposal

Separate collection of spent batteries is required in many regions; check the regulations in your area before discarding spent batteries. At the end of the product life, please contact our Customer Care Center to receive instructions on proper disposal of the unit. Please do not dispose of the unit in household or municipal waste. For a listing of Customer Care Center telephone numbers in your area, visit our website at www.petsafe.net.

Warranty

One Year Non-Transferrable Limited Warranty

This Product has the benefit of a limited manufacturer's warranty. Complete details of the warranty applicable to this Product and its terms can be found at www.petsafe.net and/ or are available by contacting your local Customer Care Center.

United States and Canada—Radio Systems Corporation, 10427 PetSafe Way, Knoxville, TN 37932 USA

Australia/New Zealand—In compliance with the Australian Consumer Law, Warranties Against Defects, effective January 1, 2012, the warranty details of this Product are as follows:

One Year Non-Transferrable Limited Warranty

What is covered: Radio Systems Australia Pty Ltd. (hereinafter referred to as "Radio Systems") warrants to the original retail purchaser, and not any other purchaser or subsequent owner, that its product, when subject to normal and proper residential use, will be free from defects in material or workmanship for a period of one (1) year from the purchase date. An "original retail consumer purchaser" is a person or entity who originally purchases the Product, or a gift recipient of a new product that is unopened and in its original packaging. When serviced by Radio Systems Customer Service, Radio Systems covers labour and parts for the first year of ownership; after the first year, a service or upgrade charge will apply relative to replacement of the product with new or refurbished items at Radio Systems' sole discretion.

The limited warranty is non-transferrable and shall automatically terminate if the original retail consumer purchaser resells the Radio Systems product or transfers the property on which the Radio Systems product is installed. This Limited Warranty excludes accidental damage due to dog chews; lightning damage; or neglect, alteration, and misuse. Consumers who purchase products outside of Australia, New Zealand, or from an unauthorised dealer will need to return the Product to the original place of purchase for any warranty issues.

Please note that Radio Systems does not provide refunds, replacements, or upgrades for change of mind, or for any other reason outside of these Warranty terms.

Claims Procedure: Any claim made under this Warranty should be made directly to Radio Systems Australia Pty Ltd. Customer Care Centre at:

Radio Systems Australia Pty Ltd.
PO Box 7266, Gold Coast Mail Centre QLD 9726, Australia
Australia Residents: 1800 786 608
New Zealand Residents: 0800 543 054
Email: info@petsafeaustralia.com.au

To file a claim, a proof of purchase must be provided. Without a proof of purchase, Radio Systems will not repair or replace faulty components. Radio Systems requests the Consumer to contact the Radio Systems Customer Care Centre to obtain a Warranty Return number, prior to sending the Product. Failure to do so may delay in the repair or replacement of the Product.

If the Product is deemed to be faulty within 30 days from date of original purchase, Radio Systems will organise for a replacement to be sent in advance of returning the faulty Product. A Post Bag will be included with the replacement Product for the return of the faulty Product. The Product must be returned within 7 days of receiving the replacement. If the Product is deemed to be faulty after 30 days from the date of original purchase, the consumer will be required to return the Product to Radio Systems at the consumer's own expense. Radio Systems will test and replace the faulty unit or its components and return to the consumer free of charge, provided the Product is within its said warranty period. This warranty is in addition to other rights and remedies available to you under the law. Radio Systems goods come with guarantees that cannot be excluded under the Australia Consumer Law. You are entitled to a replacement or refund for a major failure and for compensation for any other reasonably foreseeable loss or damage. You are also entitled to have the goods repaired or replaced if the goods fail to be of acceptable quality and the failure does not amount to a major failure.

Should you have any queries or require any further information, please contact our Customer Care Centre on 1800 786 608 (Australia) or 0800 543 054 (New Zealand).

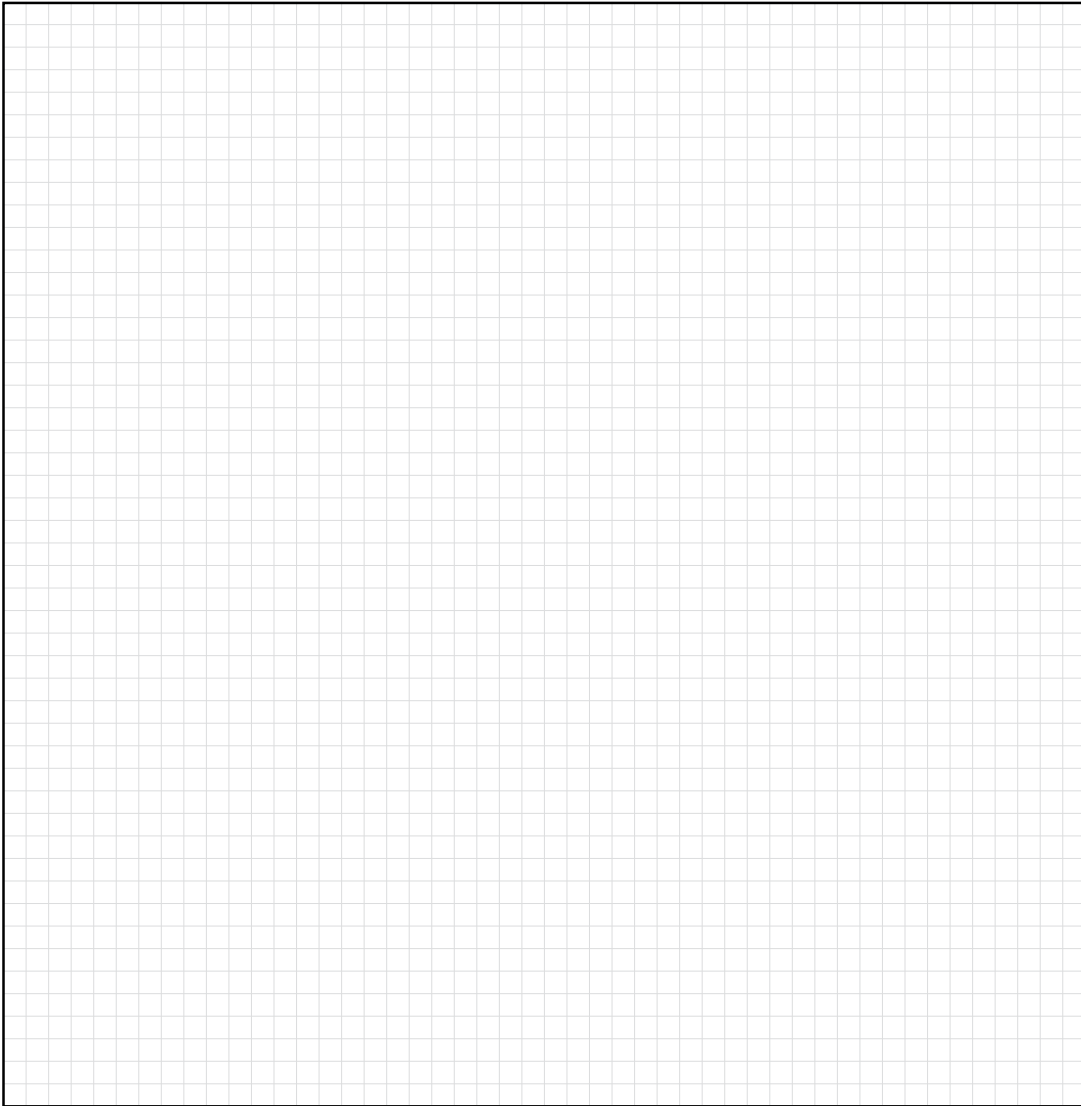

Radio Systems Corporation
10427 PetSafe Way
Knoxville, TN 37932
1-800-732-2677
www.petsafe.net

For a list of patents protecting this product, please visit:
<http://www.radiosystemscorporation.com/patents>

J400-1790/2
©2017 Radio Systems Corporation