

CARE INSTRUCTIONS

Thank you for choosing ZOOVILLAS™ SLIDE ASIDE CRATE AND END TABLE. With a little care and maintenance, ZOOVILLAS™ SLIDE ASIDE CRATE AND END TABLE will provide your pet with comfort and enjoyment for many years to come!

- To clean panels, use clean water on a damp cloth.
- When assembling ZOOVILLAS™ SLIDE ASIDE CRATE AND END TABLE, please handle all panels and/or hardware with care to avoid any possibilities of damages and/or injuries.

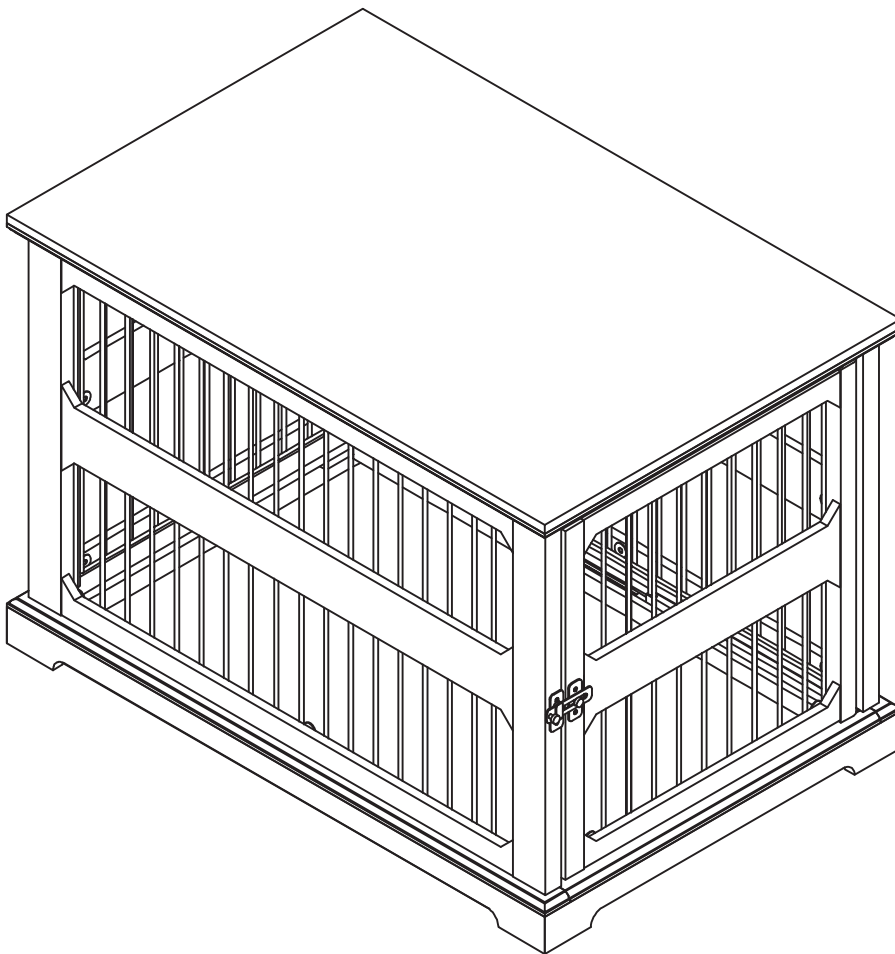

NOTE: Please read all instructions carefully before starting assembly. Also, we recommend that the unit is fully assembled on a level surface. Two people are recommended to assemble this product. DO NOT over torque screws and bolts.

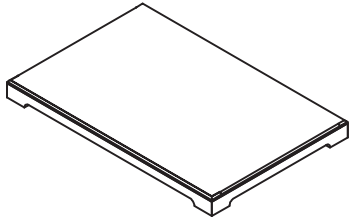

A

BOTTOM PANEL

1PC

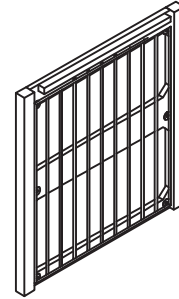

B

BACK PANEL

1PC

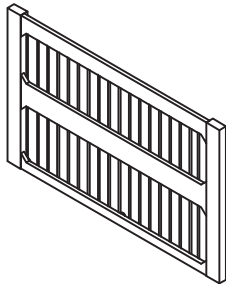

C

SIDE PANEL

1PC



D

SLIDING DOOR PANEL

1PC

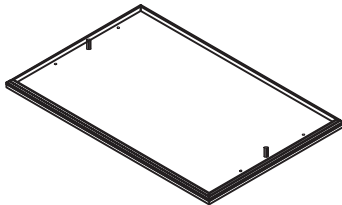

E

TOP PANEL

1PC

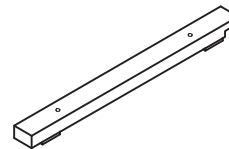





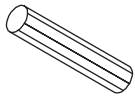

F

DOOR STOPPER

1PC

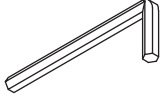
NOTE: Please read all instructions carefully before starting assembly.
Also, we recommend that the unit is fully assembled on a level surface.
Two people are recommended to assemble this product.
DO NOT over torque screws and bolts.

1		DOWEL 6x30	10+2 PCS
2		SCREW 4x35	10+1 PCS
3		SCREW 4x45	2+1 PCS
4		BOLT 6x25	4+1 PCS
5		ALLEN KEY	1 PC
6		HOLE PLUG	4+1 PCS

TOOL REQUIRED

 Phillips Screwdriver



** Power Tool NOT Recommended*

 Only slight turn of Cams required.
Do NOT overturn.

Reference this guide when assembling all Cam Locks (Hardware A+B).

1

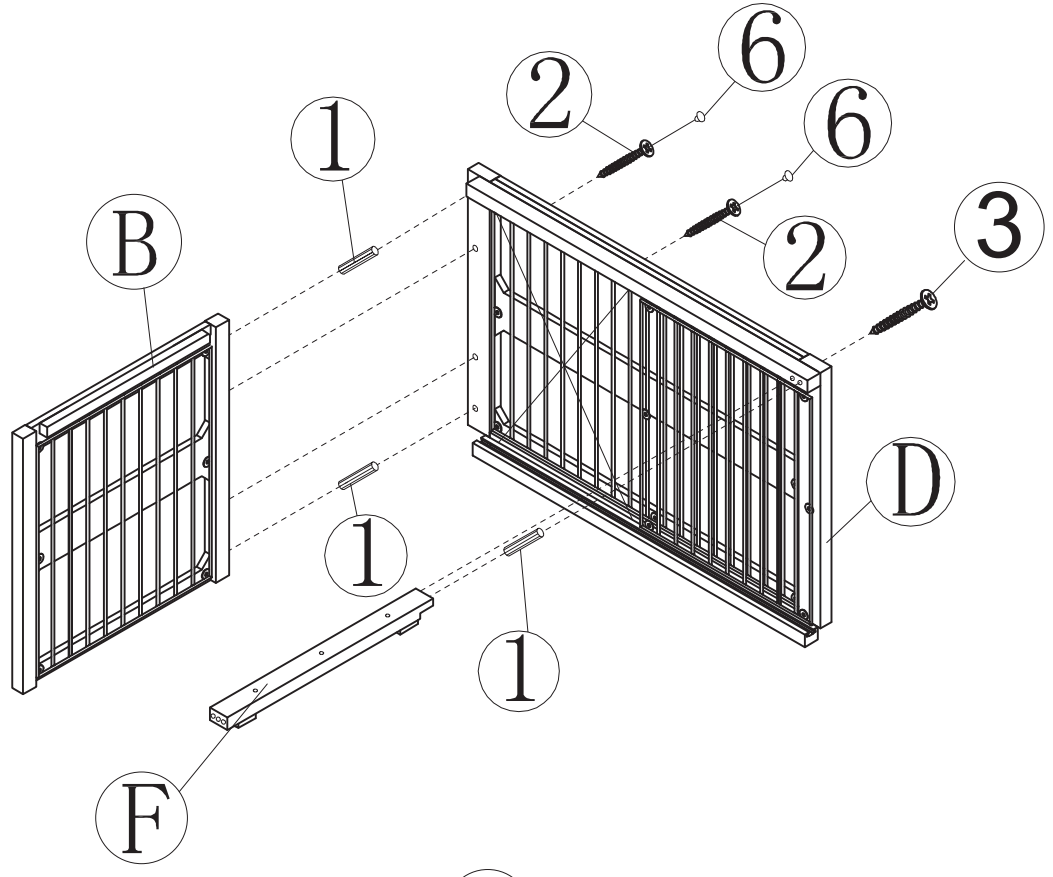

2

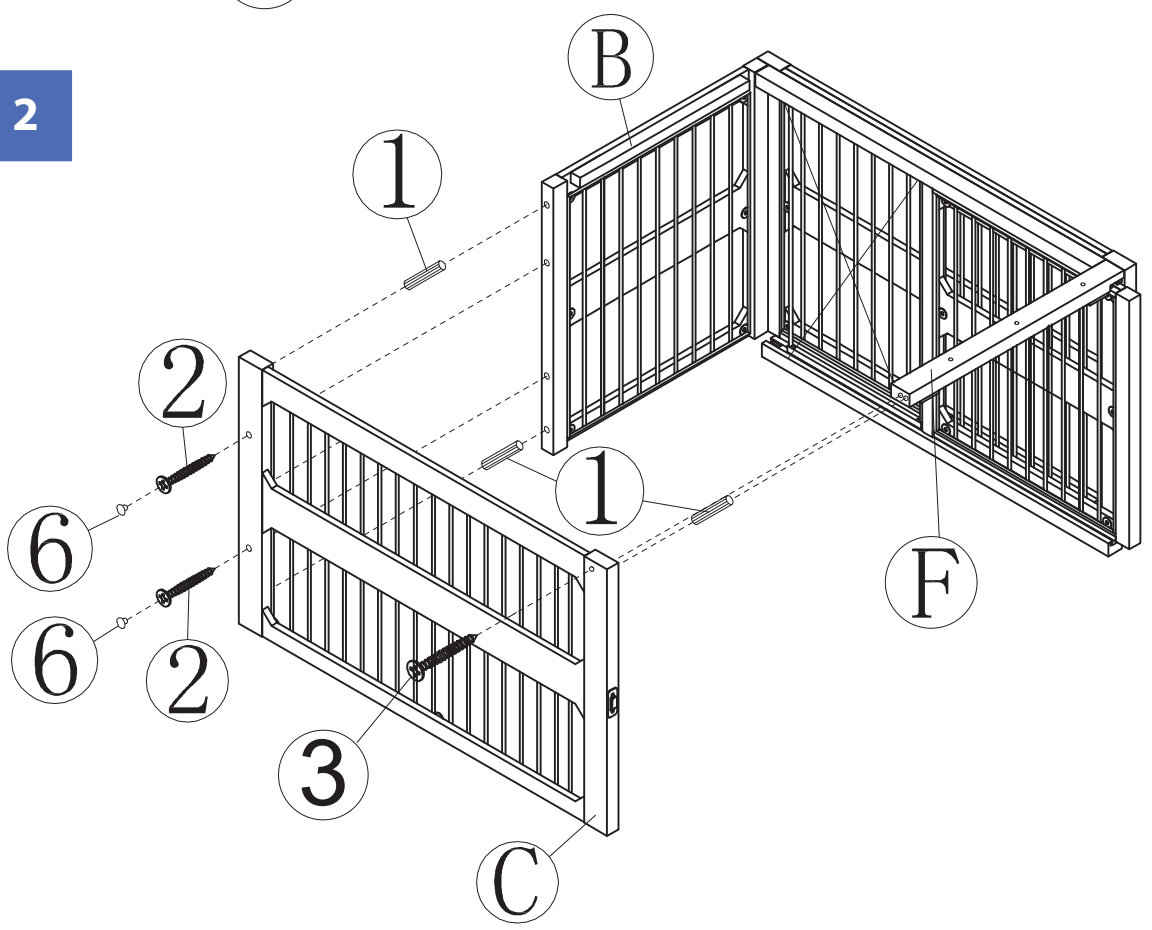

3

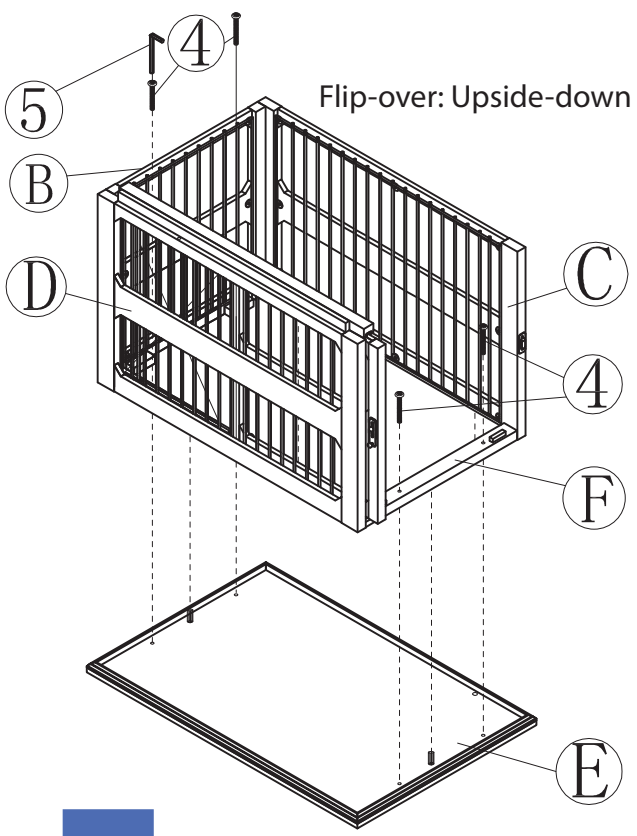

4

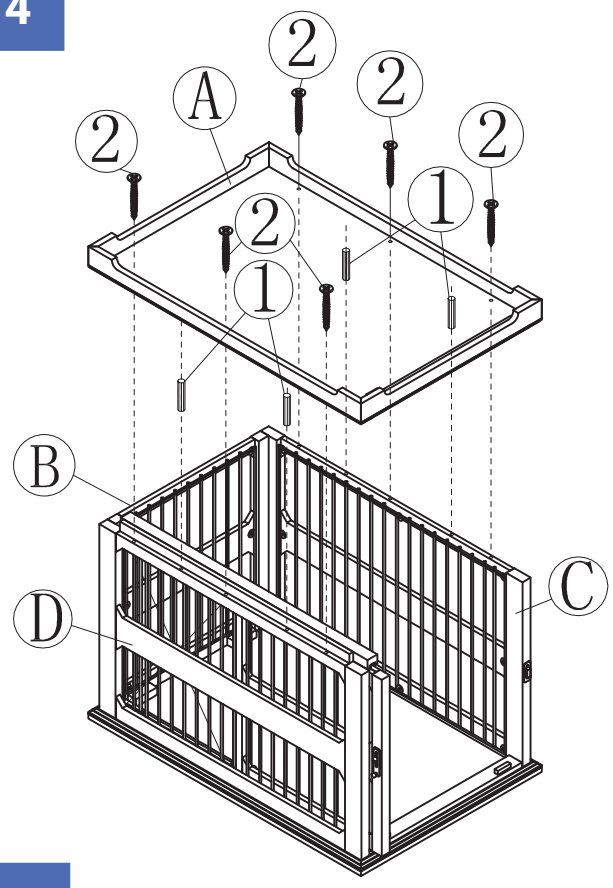

5

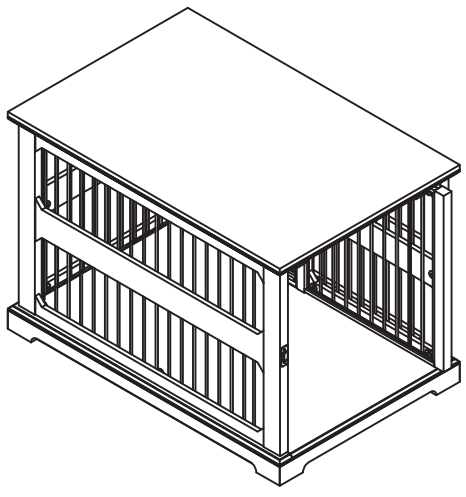

6

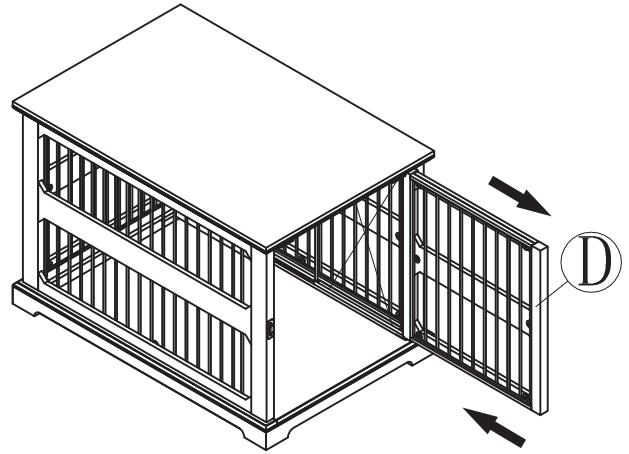

Flip-over: Right side-up

7

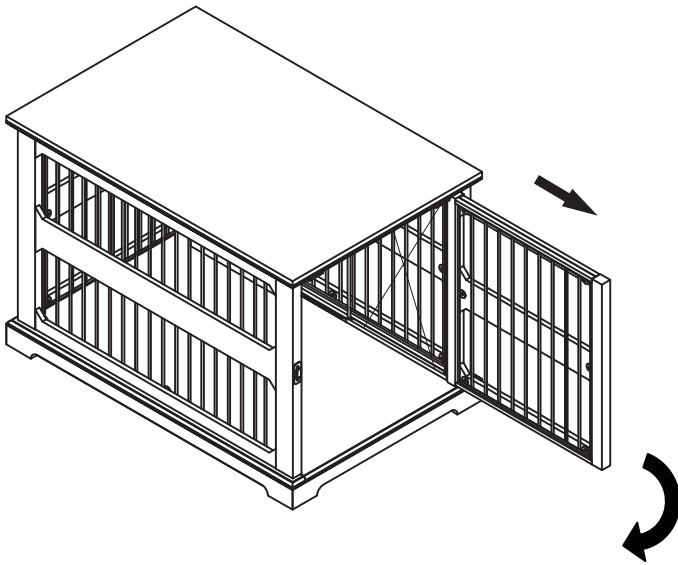

8

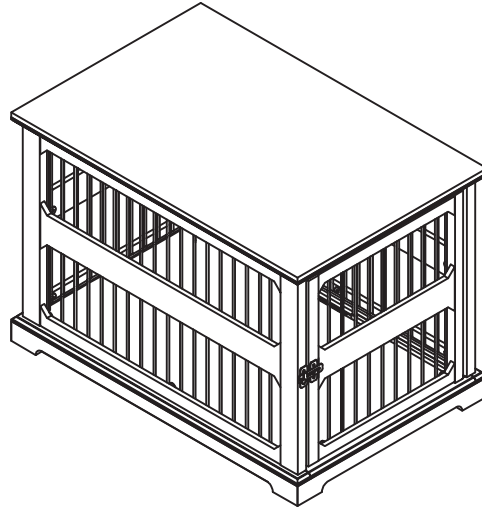

Please check contents before assembly. If any items are missing or damaged, do not take the unit back to the store. Call (775) 629-5029 or email: service@merryproducts.com for customer service and we will save you time by correcting any problems directly for you.

NOTE: Please read all instructions carefully before starting assembly. Also, we recommend that the unit is fully assembled on a level surface. Two people are recommended to assemble this product. DO NOT over torque screws and bolts.