

- Install the cable pass into the cable hole. From the outer side of the terrarium, insert the cable pass rough the cable hole. Hold the cable pass in place while turning the circular ring clockwise onto the cable pass.

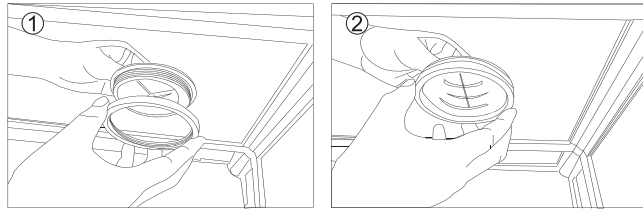

- Turn the middle piece to make the gap aim at the hole. The middle piece can be removed, Or turn the middle piece to align the two arrows, the middle part can be removed.

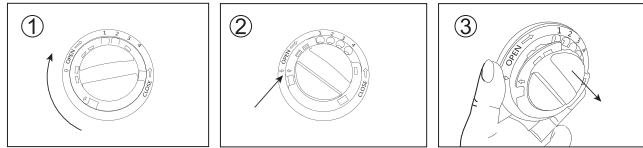

- Cable pass can be rotated to open or close the different passes. In order to pass power adapters and plugs through the cable pass, the center portion can be removed. When equipment is positioned as desired, the center piece can be reinstalled.

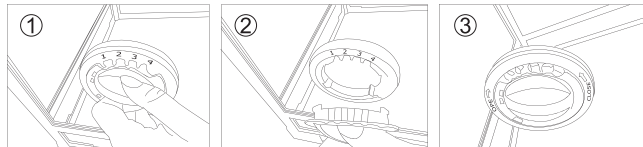

7. Install top metal ventilation mesh and the 4 rubber caps on top of the screws to cover the screws.

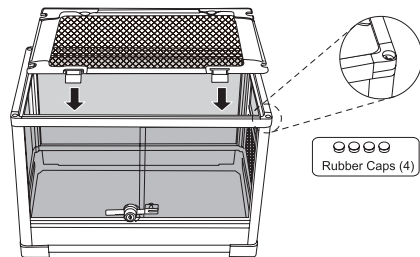

**Done!**

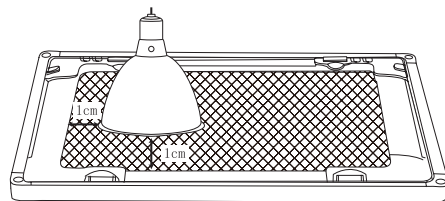

**WARNING**

The distance between the plastic frame on top of the terrarium to the edge of the heat lamp metal dome must be a minimum of 1cm, this is to prevent the burning of the plastic frame from the heat of the heat lamp metal dome.

## SLIDING DOORS TERRARIUMS INSTRUCTION MANUAL

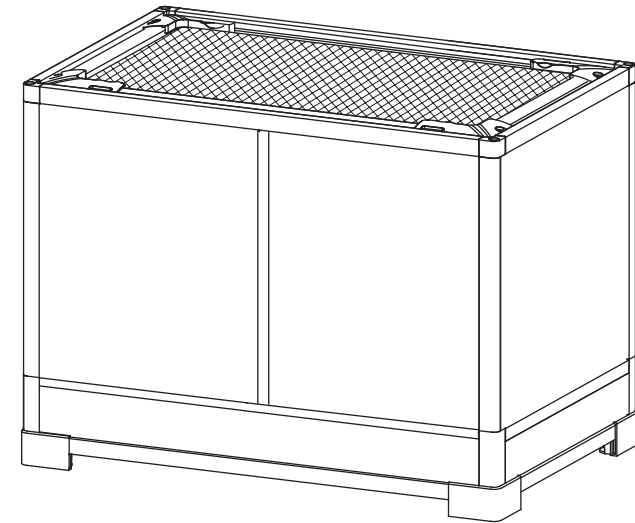

RK02

Thanks for choosing our company's products. In order to use this product properly and ensure its service life, please read the instructions book carefully before using it.

## PARTS LIST

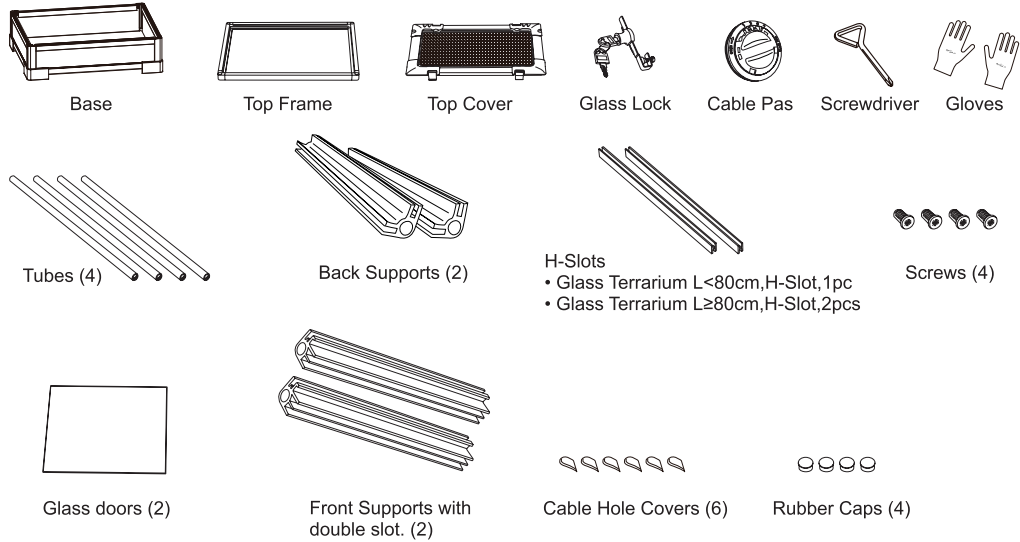

Side glass or Ventilation mesh (The following are the combination types)

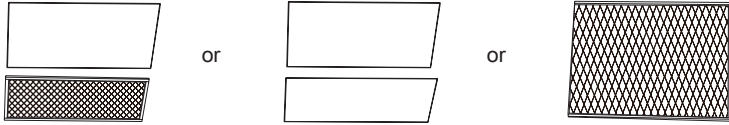

Back Glass or Ventilation Mesh

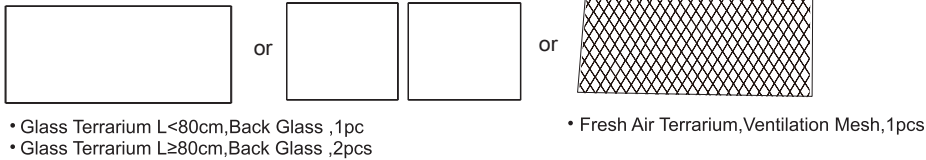

**Remark:** There are many combinations of terrarium's left / right / back side. Specific type is subject to actual product.

## INSTALLATION INSTRUCTIONS

1. Install the threaded metal tubes provided to the base. Frist Check the Numbers and Arrow marks on the metal tube, And firmly screw the metal tubes in trun onto the base of the terrarium.

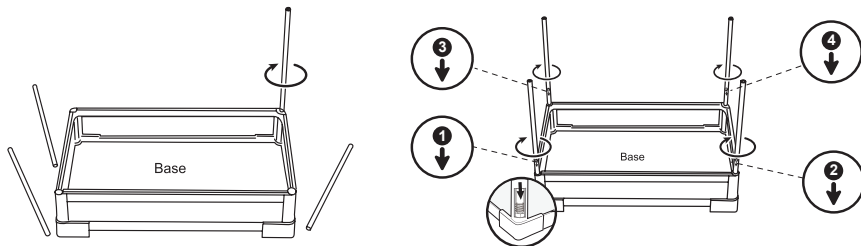

1

2. Place the two back supports to the left and right. And then place the front supports,please note that the front supports with double slot.

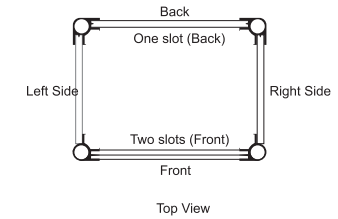
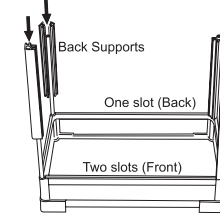

Top View

3. Install back glass and side glass panels. On one side of the terrarium, install the metal ventilation and the plastic H-slot, then install the small glass panels. Lastly install the two sliding doors.

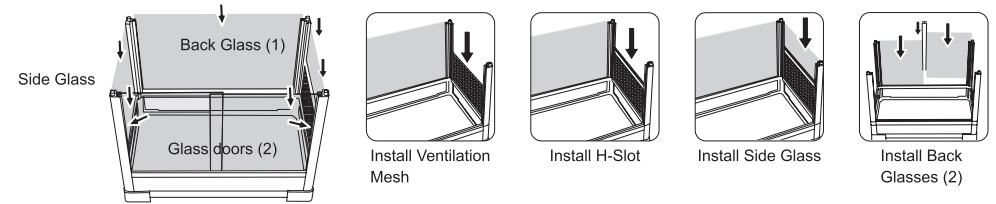

4. When all the four sides have been installed, place the top frame without the top metal ventilation mesh. Make sure that the top frame sits in properly.

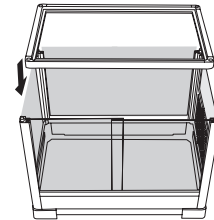

5. Screw the 4 screws firmly onto the metal tubes and then fix the glass lock in the front glass panel.

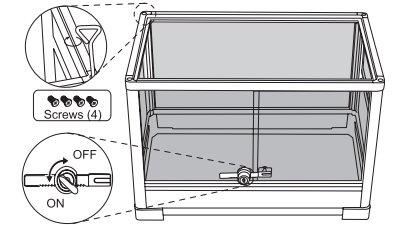

6. Install cable pass onto the side glass panel with the hole drilled.  
• Find the cable pass as pictured.

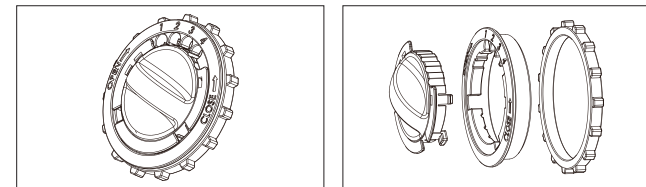

• Turn the cable pass counterclockwise while holding the retaining ring, in order to separate the two pieces.

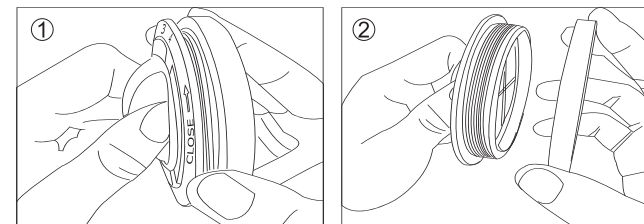

2