

frisco[®]
by **chewy**



Faux Fur Cat Tree & Condo Instruction Manual

Sku# 236556, 236557

OVERALL DIMENSIONS

30.31 IN L x 22.83 IN W x 80 IN H

77 cm L x 58 cm W x 204 cm H

ASSEMBLED BASE BOARD DIMENSIONS

29.92 IN L x 22.83 IN W

76 cm L x 58 cm W

Assembly Instructions

Please Read Through All Instructions Before Starting

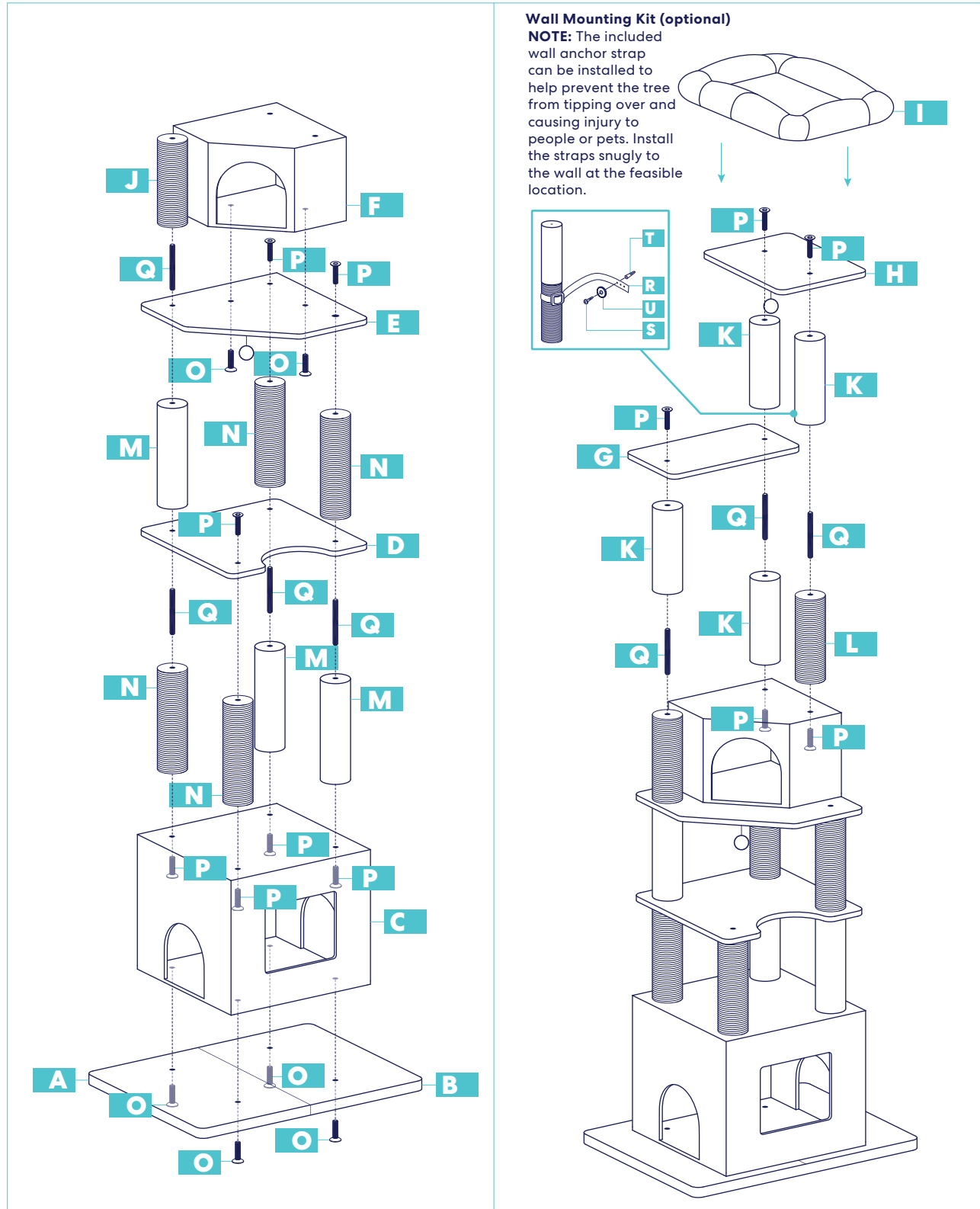

Assembly Instructions

Please Read Through All Instructions Before Starting

Parts Included

Prior to assembly, please be sure to identify and sort all parts shown below.

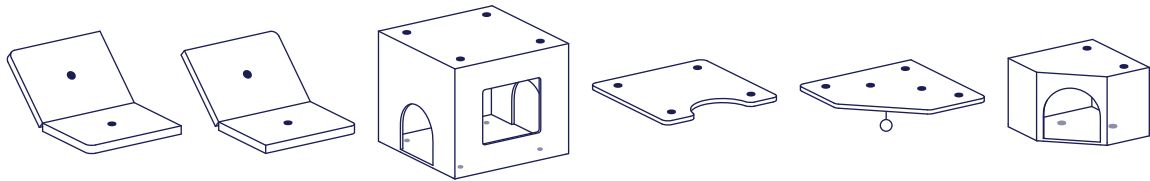

A x 1
Base Board

B x 1
Base Board

C x 1
Large Condo

D x 1
Platform

E x 1
Platform

F x 1
Small condo

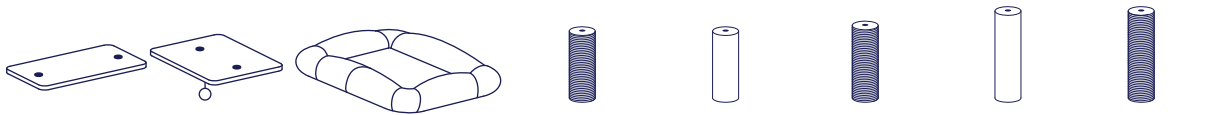

G x 1
Platform

H x 1
Platform

I x 1
Bolstered
Perch cover

J x 1
250mm
Scratching Post

K x 4
250mm
Post

L x 1
265mm
Scratching Post

M x 3
350mm
Post

N x 4
350mm
Scratching Post

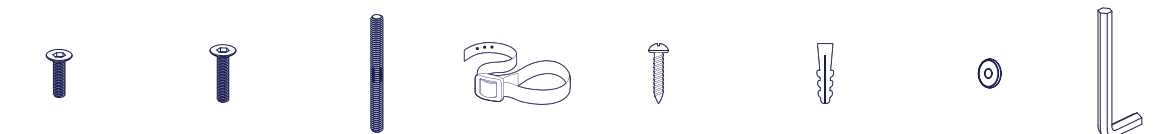

O x 6
M10*35mm
Bolt

P x 12
M10*40mm
Bolt

Q x 7
M10*85mm
Double-side Bolt

R x 1
Strap

S x 1
M4*40mm
Screw

T x 1
40mm
Drywall Anchor

U x 1
Ø20mm
Washer

V x 1
Wrench

Assembly Instructions

Please Read Through All Instructions Before Starting

Step 1.

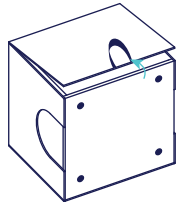

Please lift open to find all the parts. After all the parts are taken out, press down the hook-and-loop firmly on the back panel to form the condo before assembly.

Step 2.

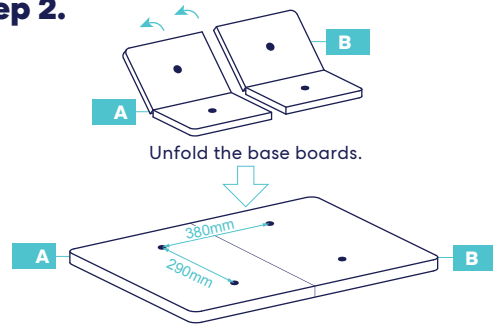

Unfold the base boards.

Step 3.

Place base boards fabric side down.

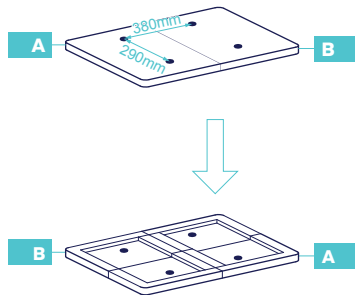

Step 4.

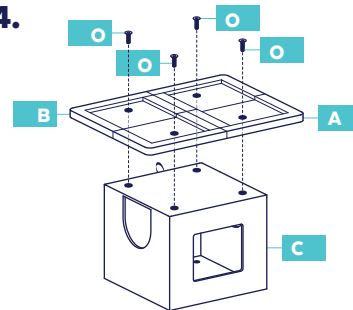

For easier assembly, use the wrench key to locate and align the 4 holes between base board and the square condo. Loosely attach each screw without completely tightening, repeat for all 4 screws. Then, tighten all 4 screws.

Step 5.

Please turn back to upright position.

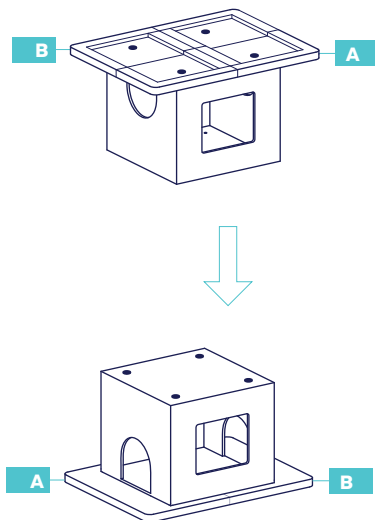

Step 6.

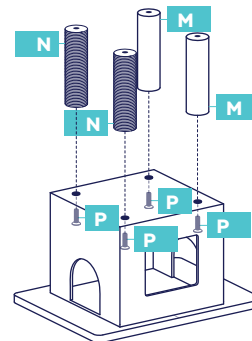

Assembly Instructions

Please Read Through All Instructions Before Starting

Step 7.

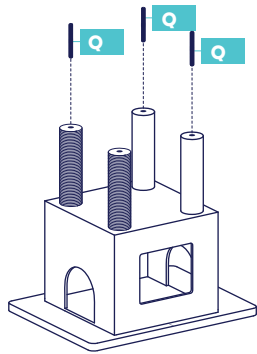

Step 8.

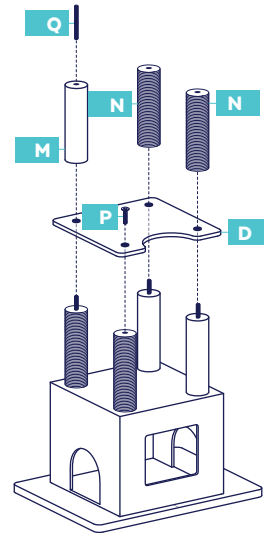

Step 9.

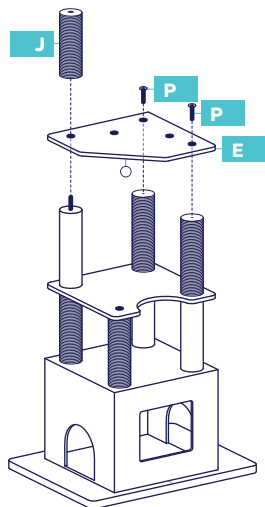

Step 10.

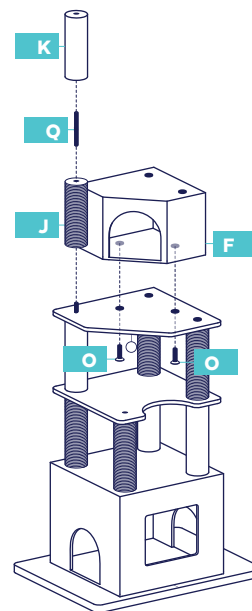

Assembly Instructions

Please Read Through All Instructions Before Starting

Step 11.

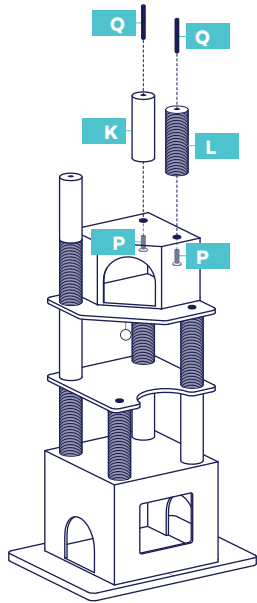

Step 12.

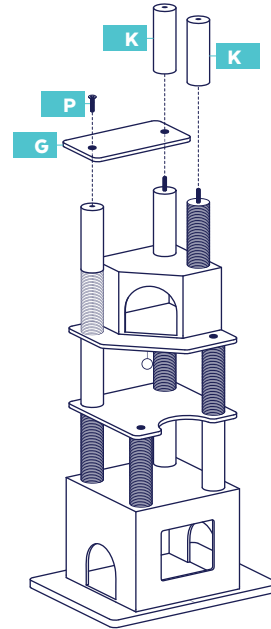

Step 13.

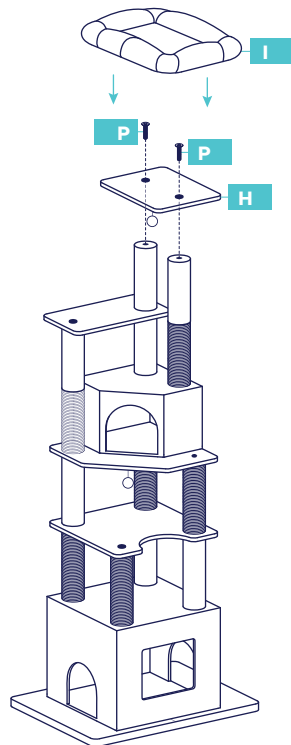

Step 14.

Wall Mounting Kit (optional)

NOTE: The included wall anchor strap can be installed to help prevent the tree from tipping over and causing injury to people or pets. Install the straps snugly to the wall at the feasible location.

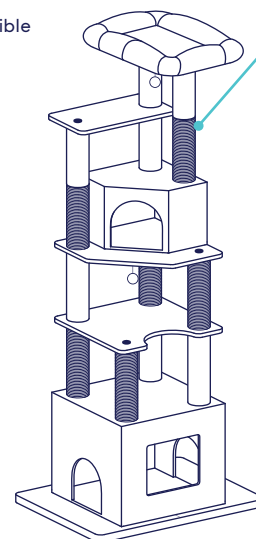
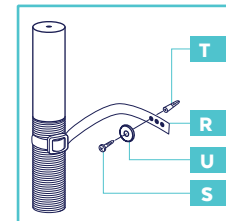

Warning & Cautions

Please read and follow all warnings and instructions to avoid pet injury or property damages.

This cat tree is intended for single cat use only, please keep children away.

Keep all small parts away from children / pets to avoid choking hazards.

Keep all tools and instructions in a safe place for future reference.

Follow the instructions carefully and make sure you've completed each step.

Never climb, rock, shake, step or hang on the cat tree.

Place your cat tree indoors, away from direct sunlight or damp areas.

Cat trees should be placed on a flat, level surface for stability.

Check your cat tree often for loose screws or parts that might need re-tightening.

If your cat tree gets torn or damaged, please discard it.

The product photo may vary slightly from your fully assembled cat tree as this product is continually being enhanced.

Cleaning & Instructions

Spot clean stains and vacuum fur (using small handheld or attachment) when necessary.

Questions?

Call our friendly customer service anytime.
We're here 24/7 at 1.800.672.4399