

frisco.
better pet goods

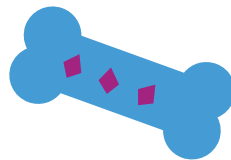
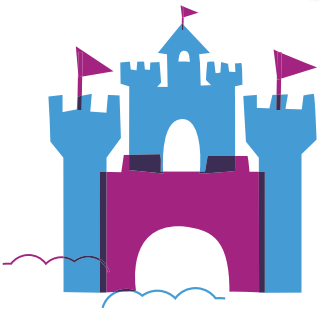
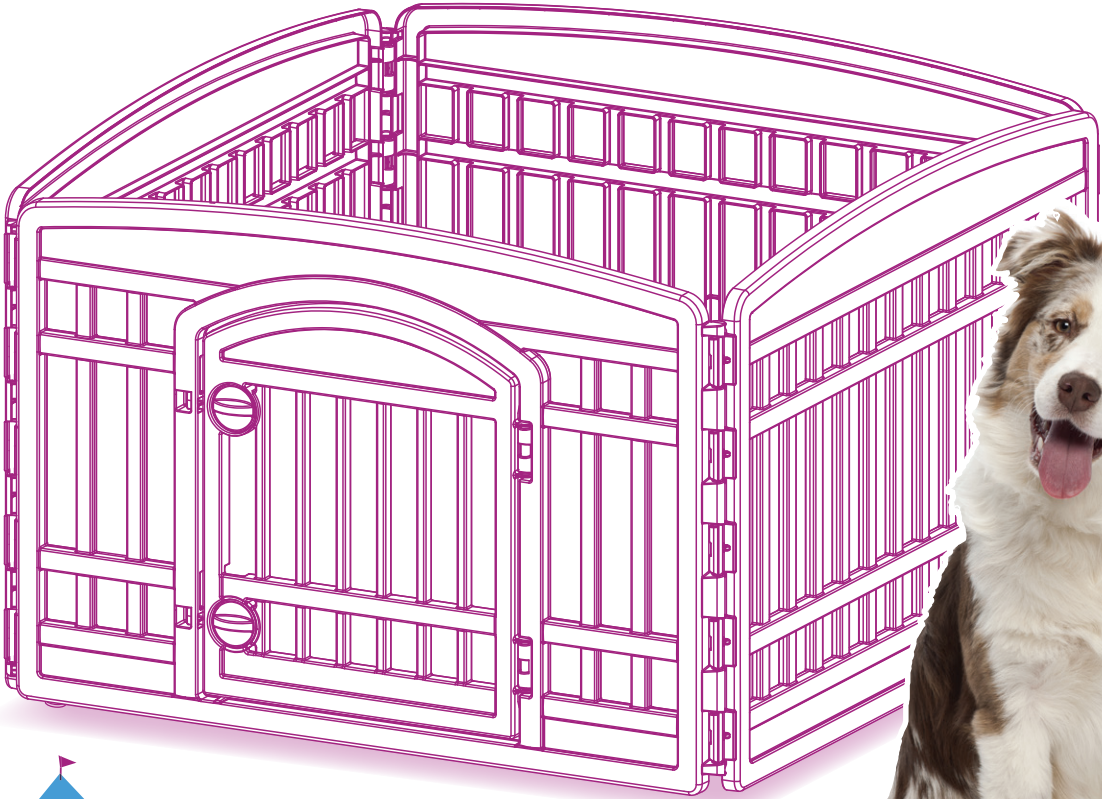
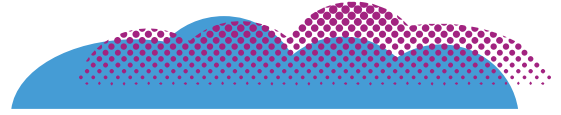

SKU# 239691,
244546, 244547

4-PANEL PLASTIC EXERCISE DOG PLAYPEN

INSTRUCTION MANUAL

PARTS INCLUDED

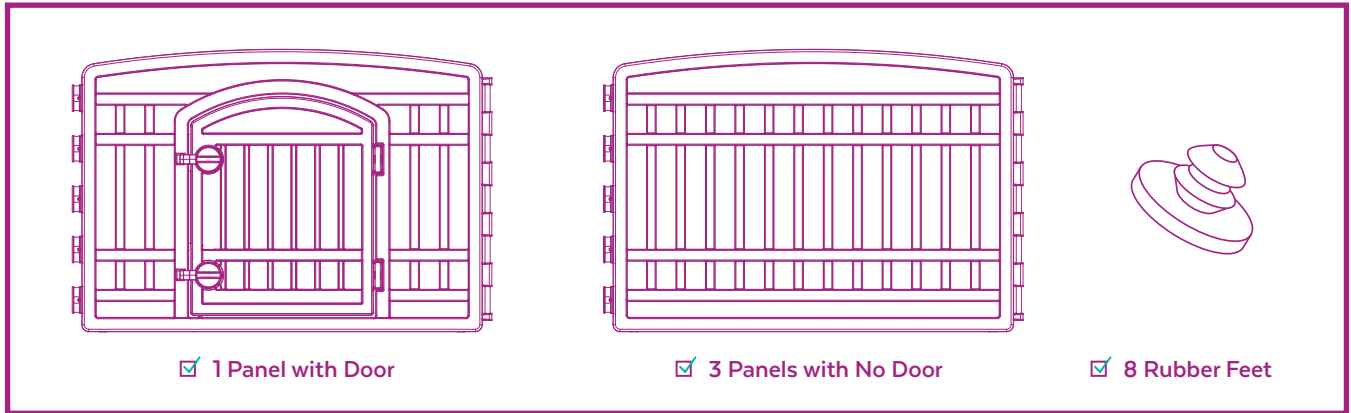

DOG PLAYPEN ASSEMBLY INSTRUCTIONS

Gloves suggested to avoid injury during assembly. Please assemble on a flat surface, and be careful not to scratch the floor.

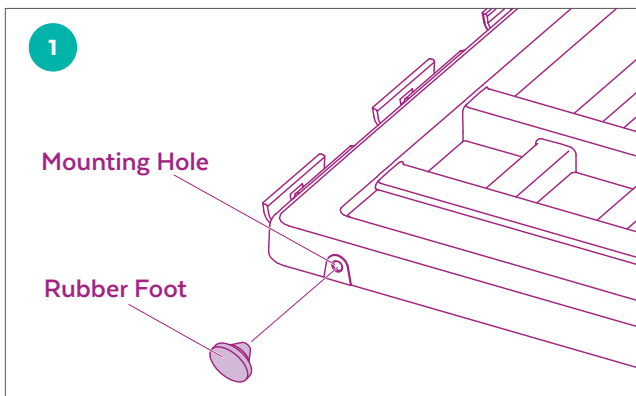

STEP 1 Connect the rubber feet to each panel. (2 rubber feet on each panel)

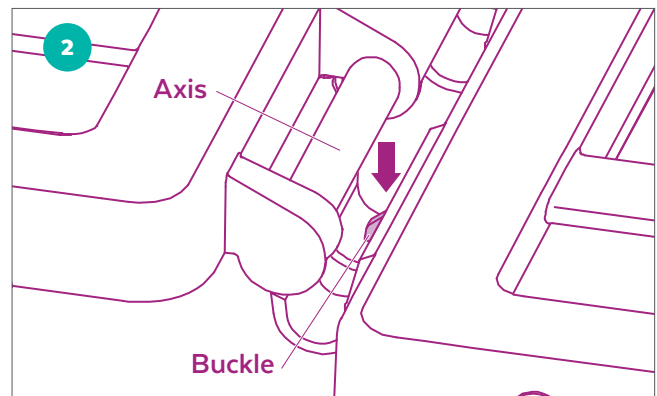

STEP 2 Connect the panels by pressing the axis downward into buckle to snap it into place.

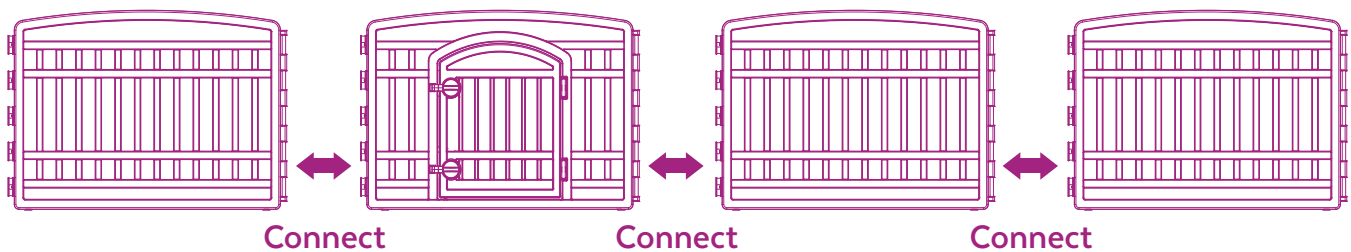

This illustrates how to arrange and connect the panels. CAUTION, be careful not to pinch your fingers or hand when attaching.

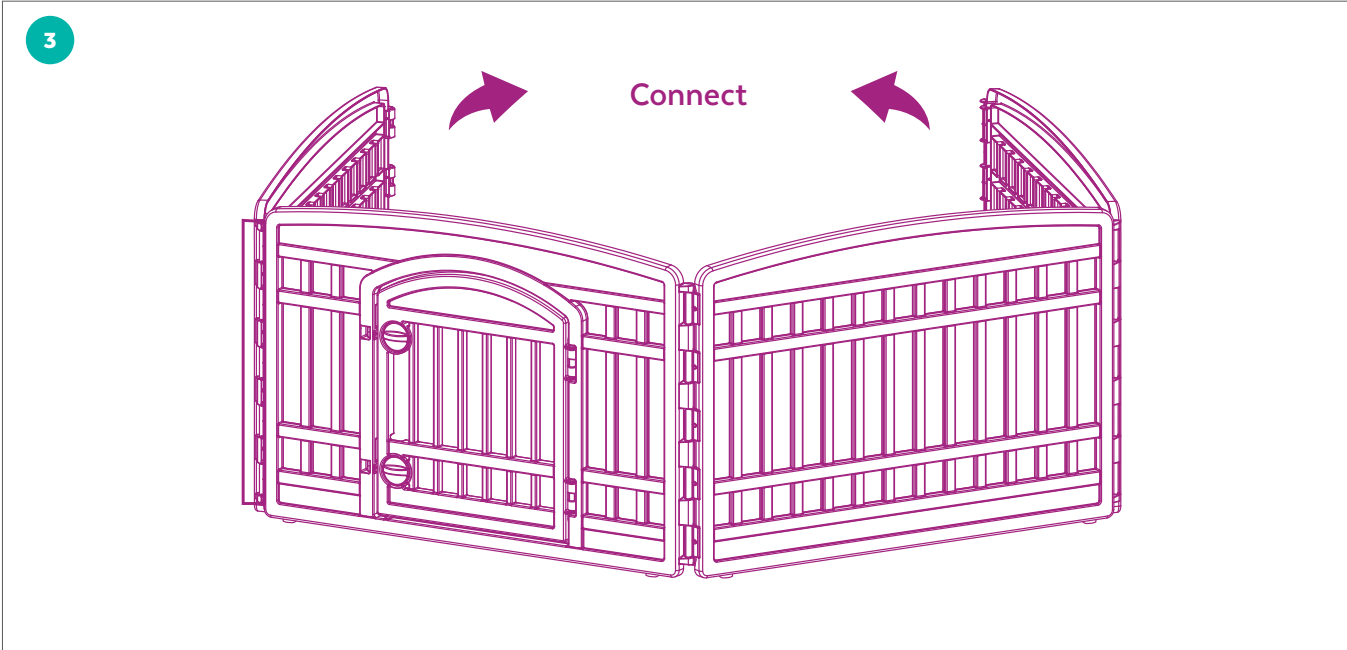

STEP 3 Connect all the panels to finish the installation, as shown in the figure.

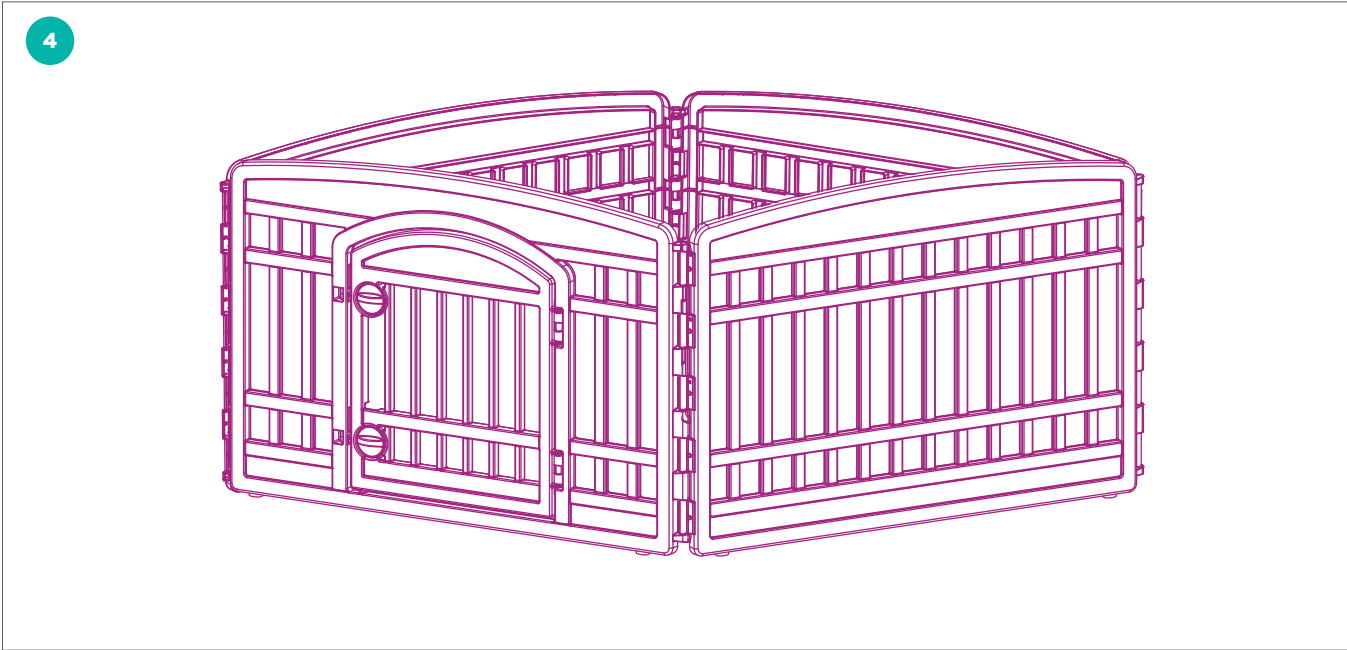

STEP 4 Connect all the panels to finish the installation.

LOCKING AND UNLOCKING
Rotate the handles to open or close the door of the pet pen. (2 handles total)

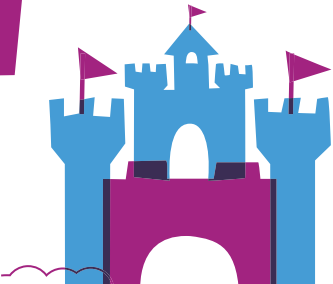



CLEANING TIPS

- Clean away dirt with diluted neutral detergent. Wipe away any remaining residue with a damp cloth.
- Do not clean with ethyl alcohol, gasoline, decolorizer or cleanser.
- Make sure to dilute the methylphenol solution or other sanitizers before use.

WARNINGS AND CAUTIONS

We care about the safety of your pet, so please READ AND FOLLOW ALL INSTRUCTIONS before using a new crate. Improper use may result in serious injury or even the death of your pet.

- For indoor use only.
- Do not place the product on uneven ground. Make sure to place it on a flat, firm surface.
- Do not place it near open fire or other sources of high heat, and do not pour hot water on it. Doing so may lead to fire, burns for people and pets, or deformation of the product.
- The product is not suitable for pets whose heads are smaller than the gap between the grids of the panels.
- Not intended for use with children. Children should not be allowed to play in the pet pen.
- Due to ages, breeds and sizes, personalities, and other individual differences, it is possible that some pets may get stuck in the gaps in the panels or may be able to escape from the pet pen.
- Do not apply too much force when moving or adjusting the product.
- Do not pinch your pet or fingers when opening or closing the pet pen.
- Do not move the pet pen with your pet inside.
- Be careful when using on easily damaged floors. Moving the pen too roughly could create scratches or nicks on the floor.
- Extended periods of use may cause discomfort for your pet. Please ensure your pet's physical needs are met.
- Collars and chains may get stuck on the pet pen. Use of these items while in the pen could lead to injury or accident.
- Make sure the pet pen door has been securely closed and locked, otherwise you pet may be able to escape.
- Some pets may be able to figure out how to open the pet pen door. In this case, please use a padlock.
- To avoid deformation or discoloration, please pay attention to the following:
 - Do not use in places with direct sunlight or in hot and humid environments.
 - Please wipe away any moisture, oil, or detergent on the product as soon as possible.
 - Do not place anything wet or hot inside the product.

QUESTIONS?

**CALL OUR FRIENDLY CUSTOMER SERVICE TEAM ANYTIME.
WE'RE HERE 24/7! 1-800-67-CHEWY (672-4399)**