

UNIVERSE HOME INC

ASSEMBLY AND CARE INSTRUCTION

Dog Crate

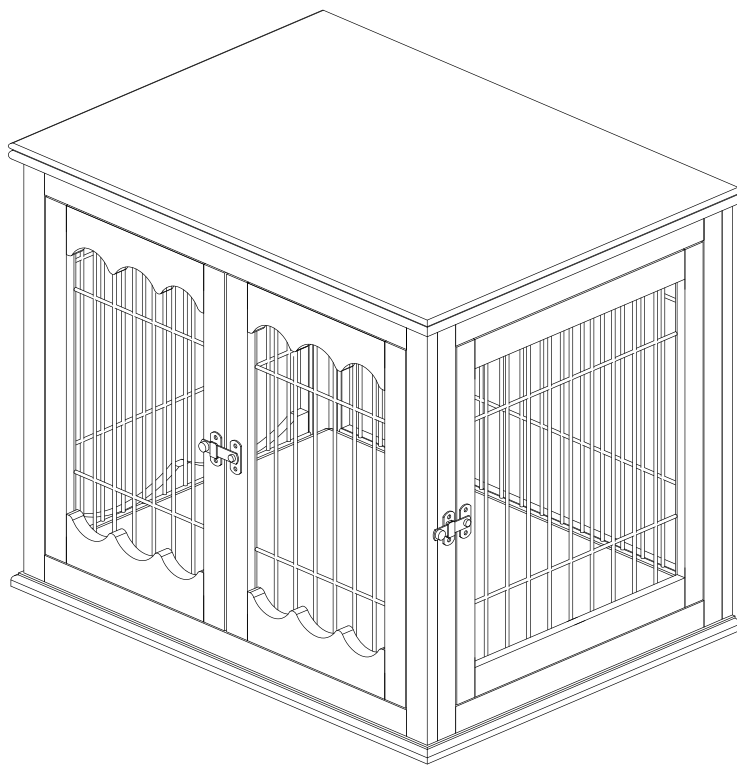

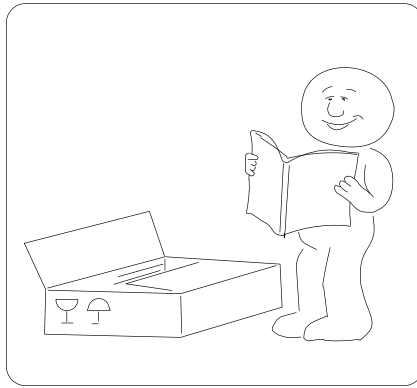
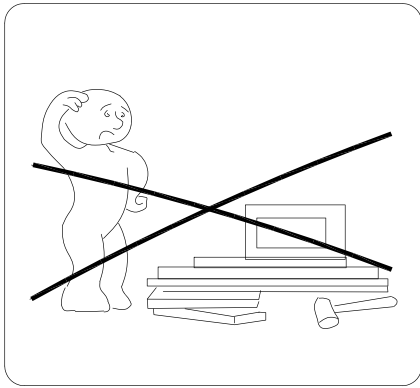

WARNING



1. PLEASE READ ALL INSTRUCTIONS CAREFULLY BEFORE STARTING ASSEMBLY.
2. DO NOT LET ANY SHARP OBJECTS TOUCH OR RUB THE SURFACE OF THE PRODUCT.
3. WHEN ASSEMBLING, DO NOT LET CHILDREN PLAY AROUND THE WORKING AREA.
4. PLEASE CONFIRM ALL PARTS ARE CORRECT BEFORE STARTING THE ASSEMBLY PROCESS.
5. DO NOT TIGHTEN ALL BOLTS AND SCREWS COMPLETELY UNTIL THE ENTIRE UNIT HAS BEEN ASSEMBLED AND SET UP.

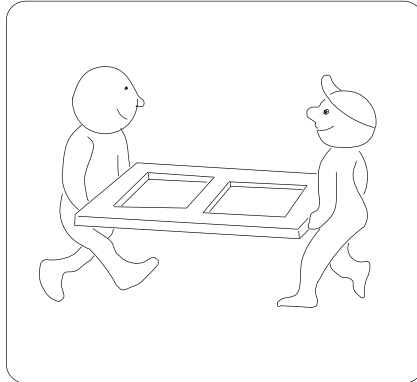
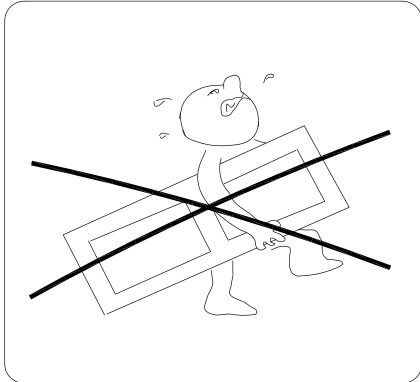
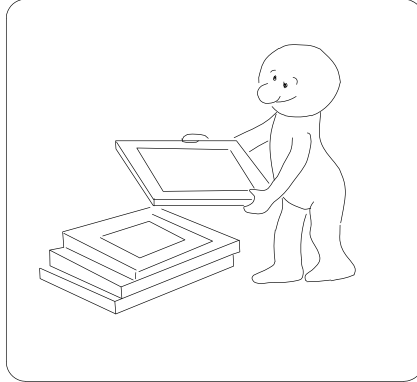
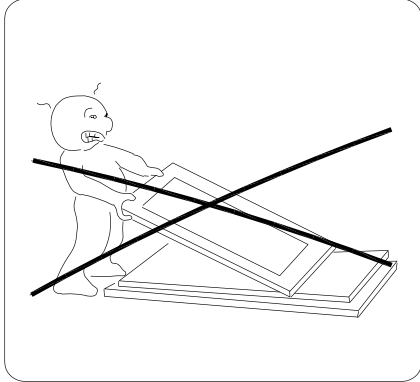

ADVISE

1. DO NOT SIT OR STAND ON THIS PRODUCT. IT IS INTENDED FOR PETS ONLY.
2. THIS PRODUCT SHOULD BE ASSEMBLED BY AN ADULT.
3. PLEASE PUT THE PRODUCT ON A SMOOTH SURFACE AFTER YOU ASSEMBLED IT.
4. PLACE ALL PARTS ON A CLEAN AND SMOOTH SURFACE SUCH AS A RUG OR CARPET TO AVOID THE PARTS FROM BEING SCRATCHED.
5. THE SCREW OF HINGE ON THE DOOR ALSO CAN BE ADJUSTABLE, TO MAKE IT EVEN THEN TIGHTEN ALL SCREWS.

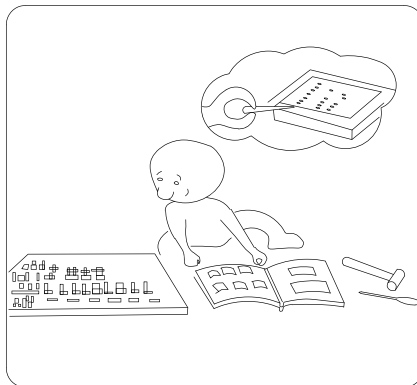
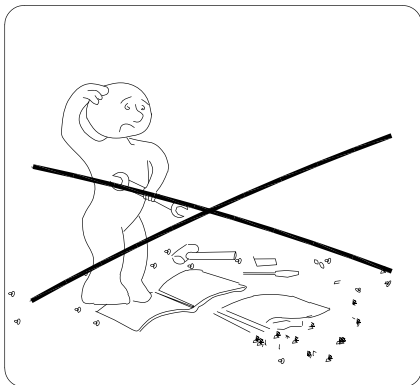

TOOL NEEDED

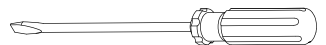
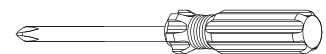

SCREWDRIVER REQUIRED
- NOT INCLUDED

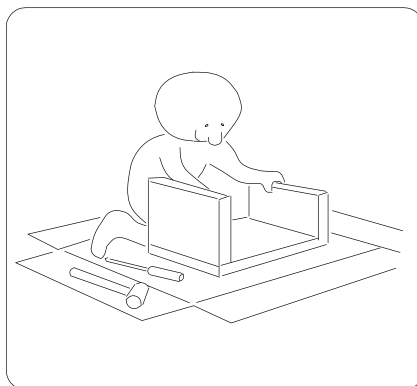
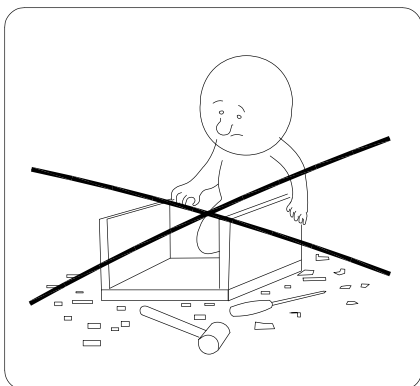

PARTS

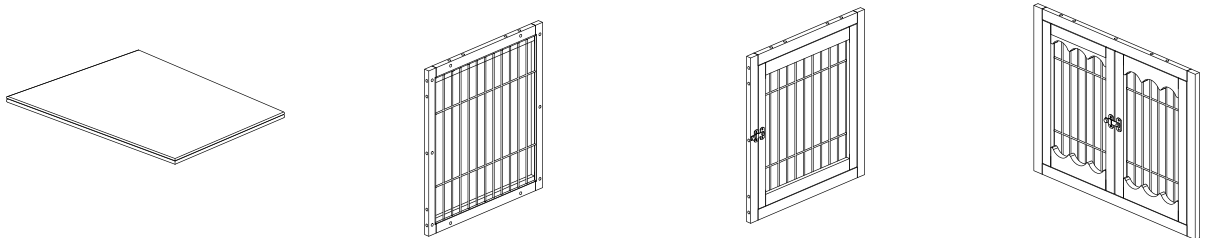
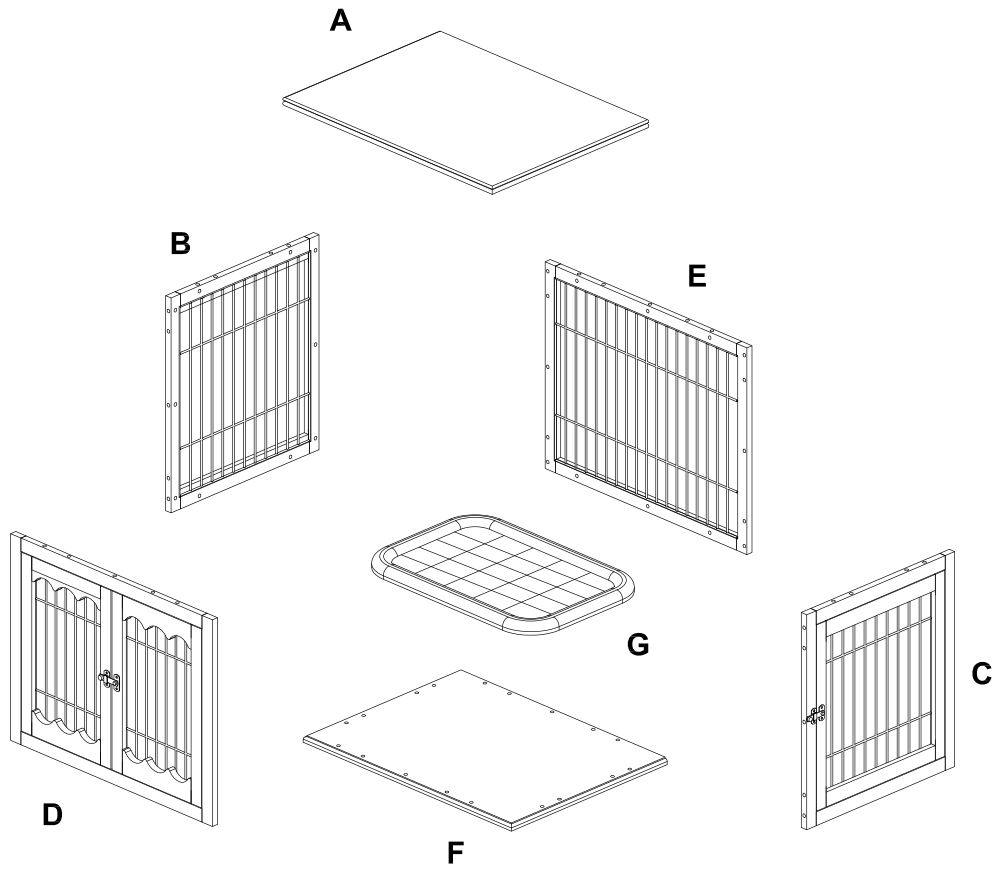

A
Top Panel
x1

B
Side Frame
x1

C
Side Frame With Door
x1

D
Front Frame
x1

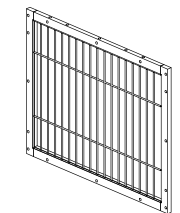

E
Back Frame
x1

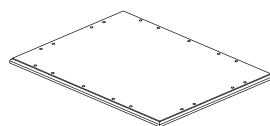

F
Bottom Panel
x1

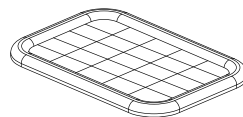

G
Cushion
x1

HARDWARE

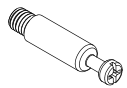

1
x 32 pcs



2
x 32 pcs



3
x 24 pcs

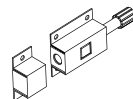

4
x 2 set



5
x 12 pcs

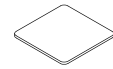

6
x 5 pcs

ASSEMBLY INSTRUCTIONS

<p>1 x 6 pcs</p>	<p>3 x 4 pcs</p>	<p>4 x 2 set</p>	<p>5 x 12 pcs</p>
-----------------------------	-----------------------------	-----------------------------	------------------------------

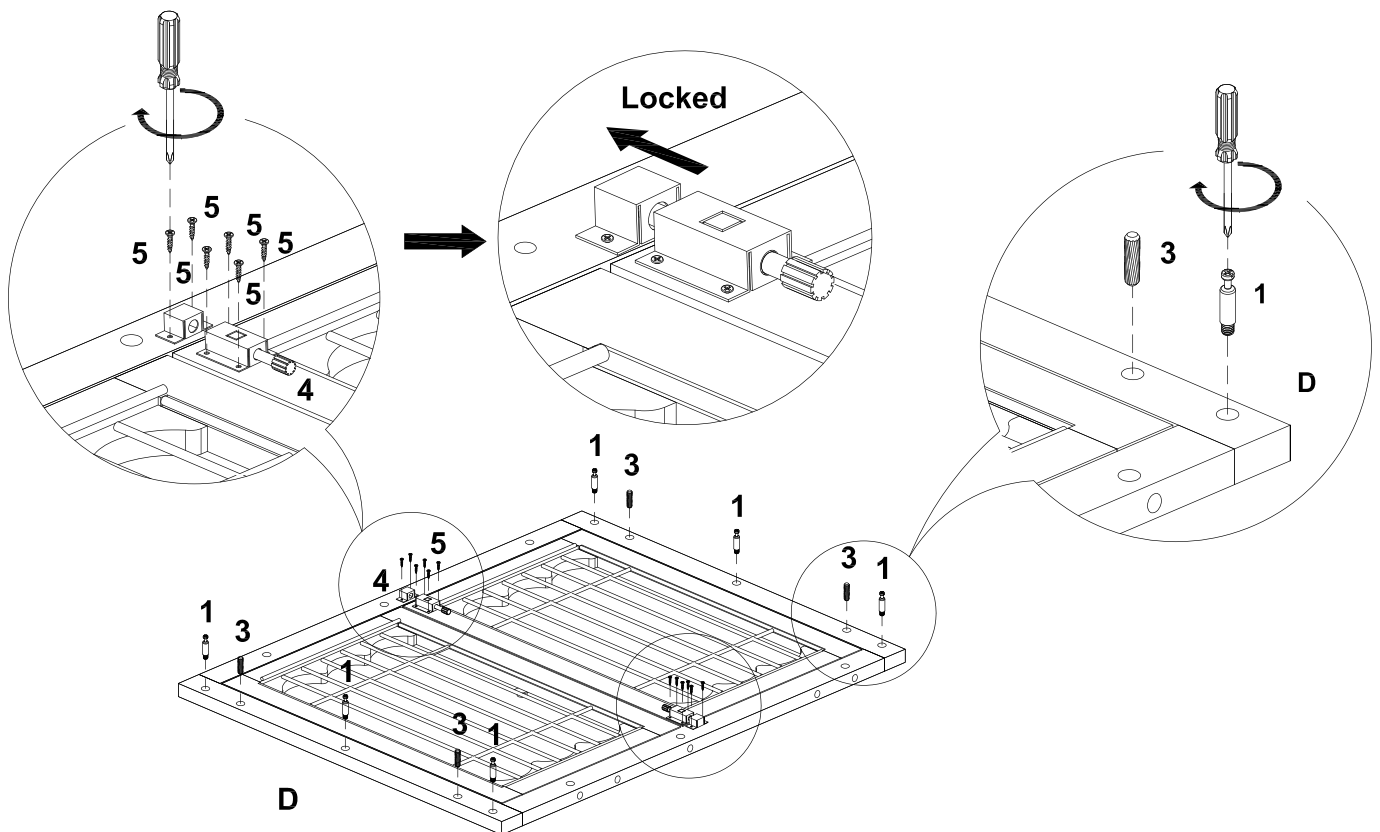

STEP 1:

1. Install the latch 4 to the front frame D and tighten them with screw 5.
2. Insert the wood dowel 3 and tighten pin 1 into the front frame D.

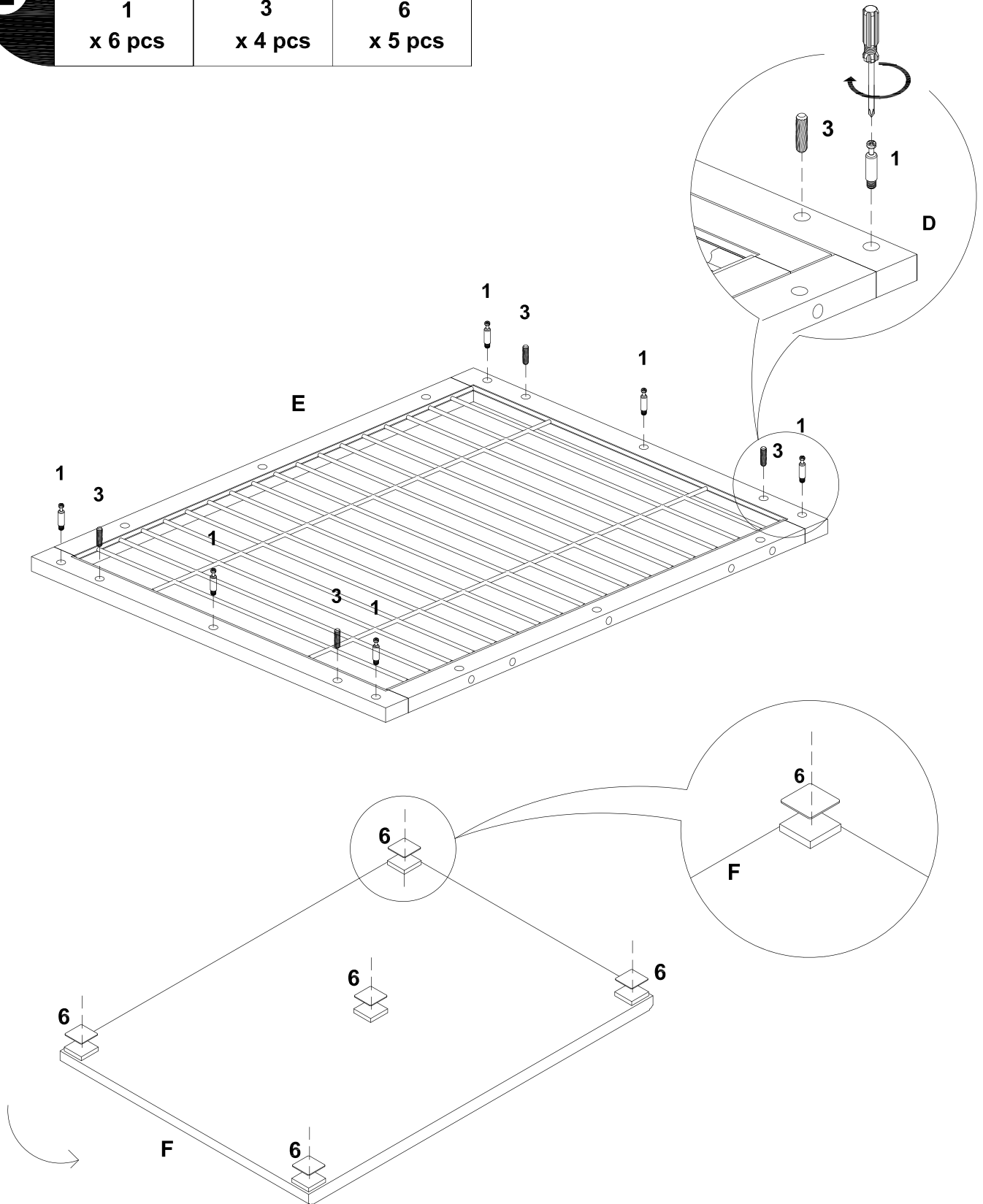
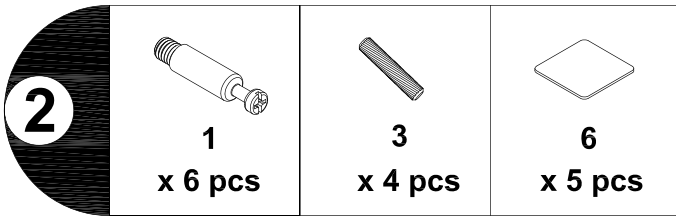

STEP 2:

1. Insert the wood dowel 3 and tighten pin 1 into the back frame E.
2. Stick five EVA pad 6 to the bottom panel F.

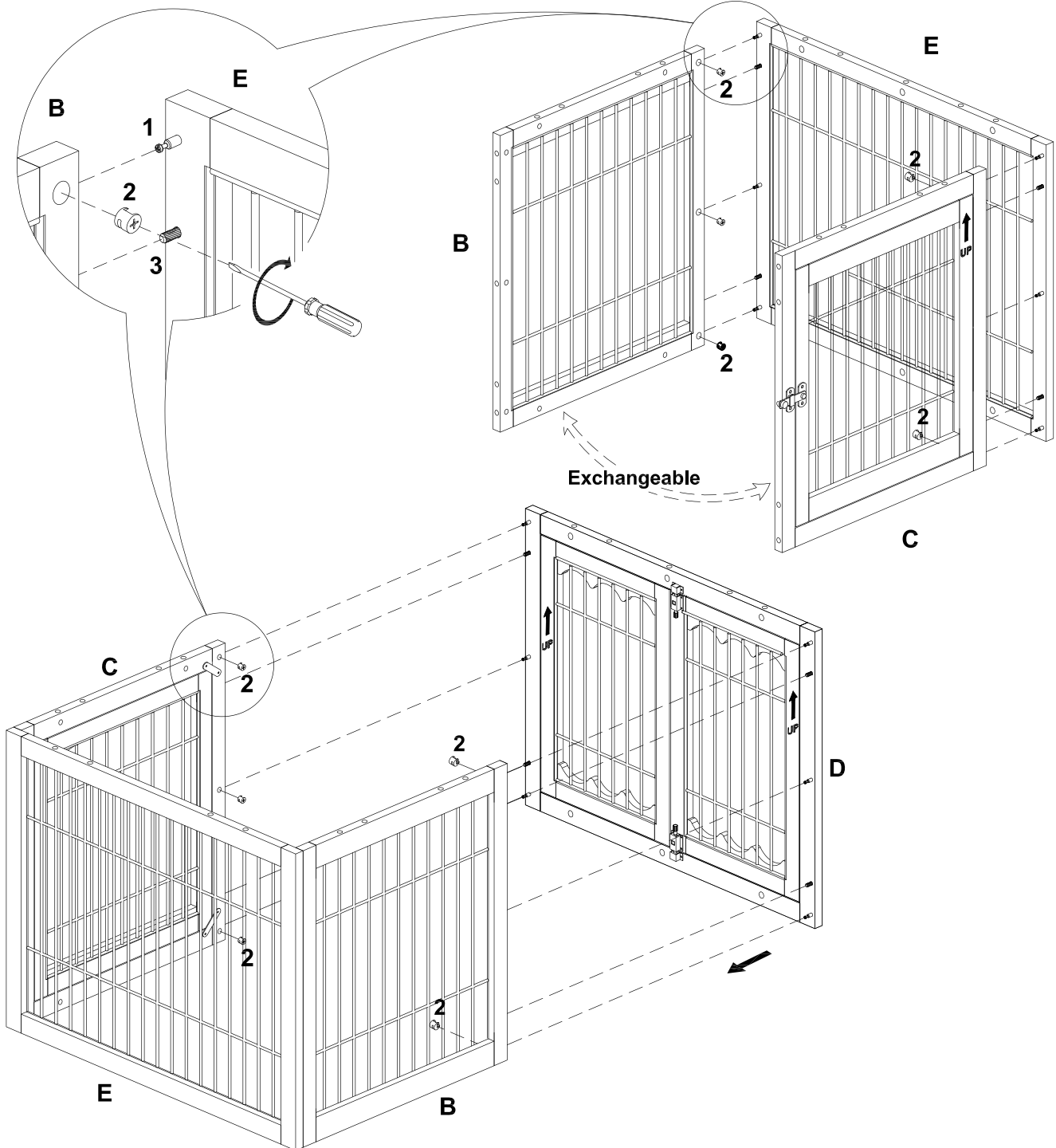
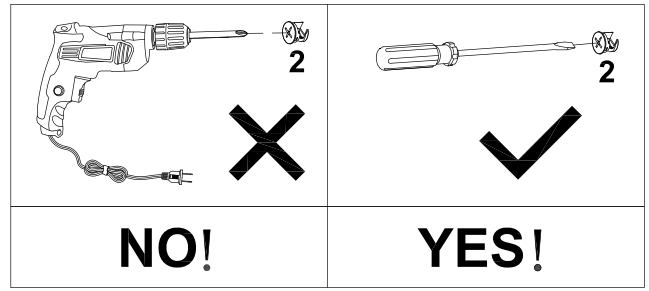
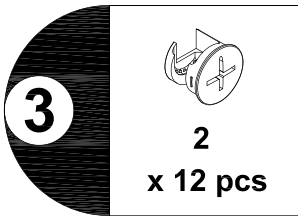

STEP 3:

1. Connect side panel B and C to back panel E, insert cam lock 2 into the hole on both side panel B and C, tighten cam lock 2 to pin 1.
2. Connect front panel D to side panel B and C, insert cam lock 2 into the hole on both side panel B and C, tighten cam lock 2 to pin 1.

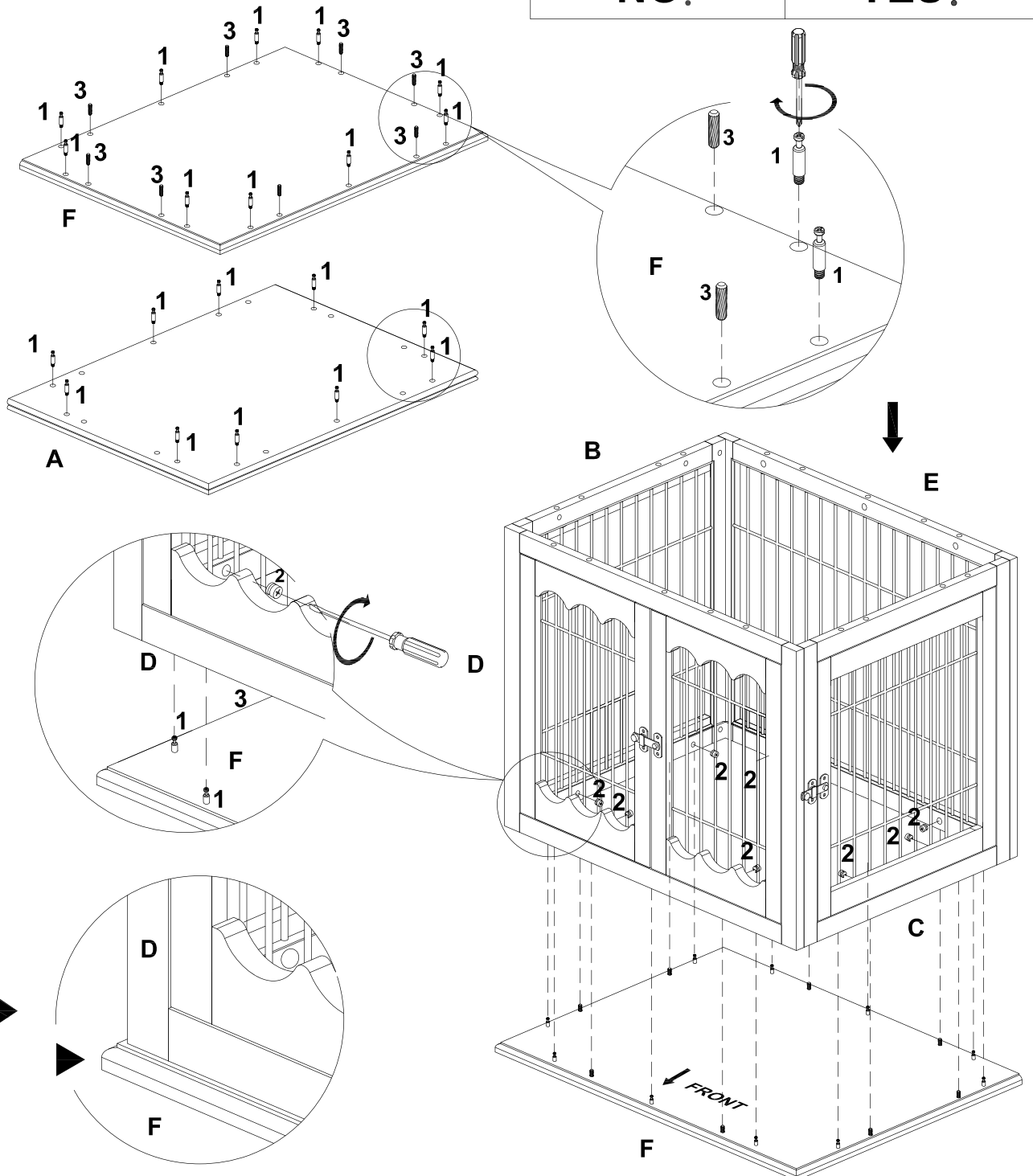
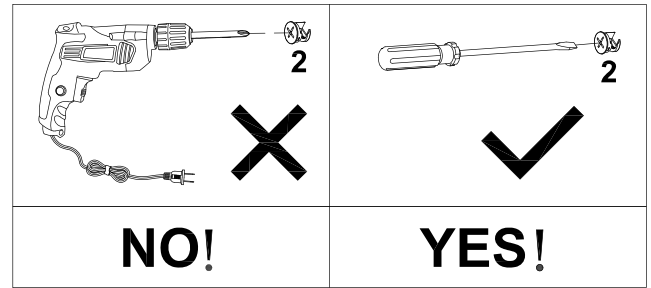
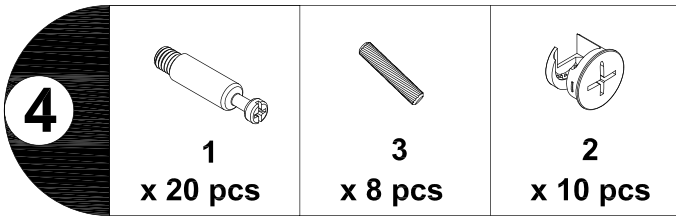

STEP 4:

1. Insert the wood dowel 3 and tighten pin 1 into the bottom panel F.
2. Tighten pin 1 into top panel A.
3. Input the assembled frame to the bottom panel F, tighten cam lock 2 to pin 1.

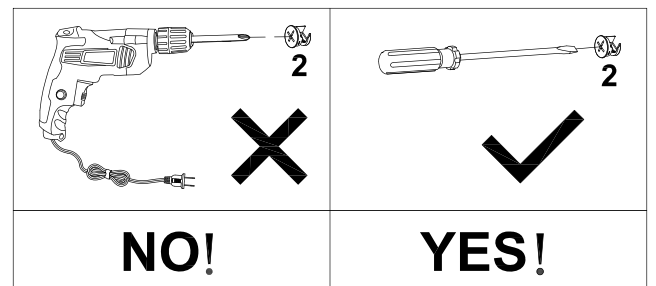
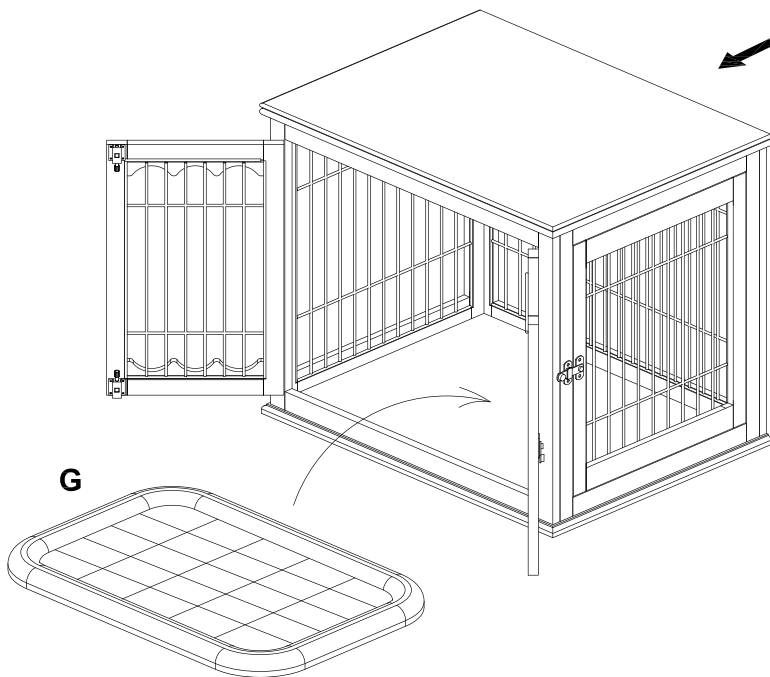
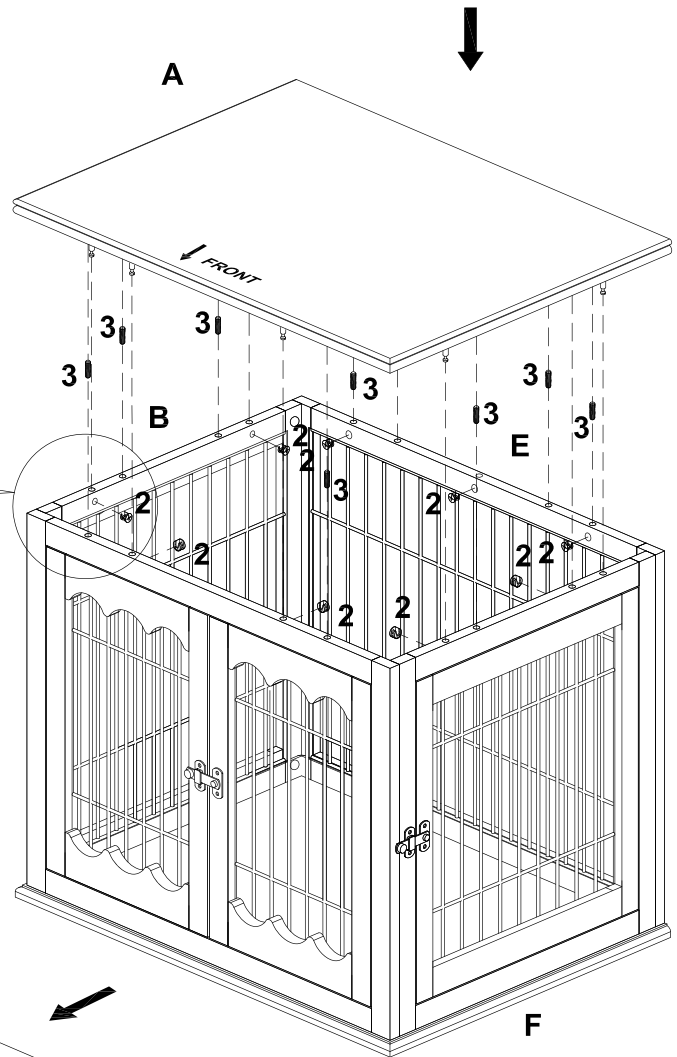
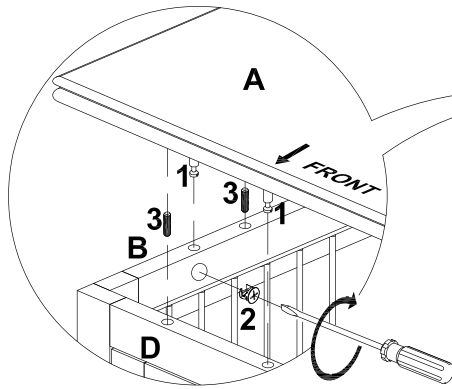
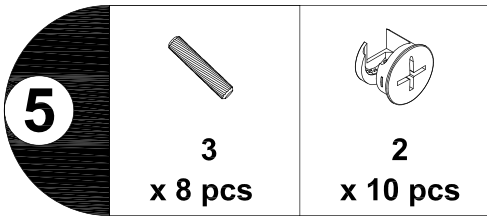

STEP 5:

1. Insert wooden dowel 3 into the assembled frame at first.
2. Input top panel A into the assembled frame and tighten cam lock 2 to pin 1.
3. Input cushion G inside the crate, assembly complete.