

**UNIVERSE HOME INC**  
**ASSEMBLY AND CARE INSTRUCTION**  
**Cat Litter Box With Mat**

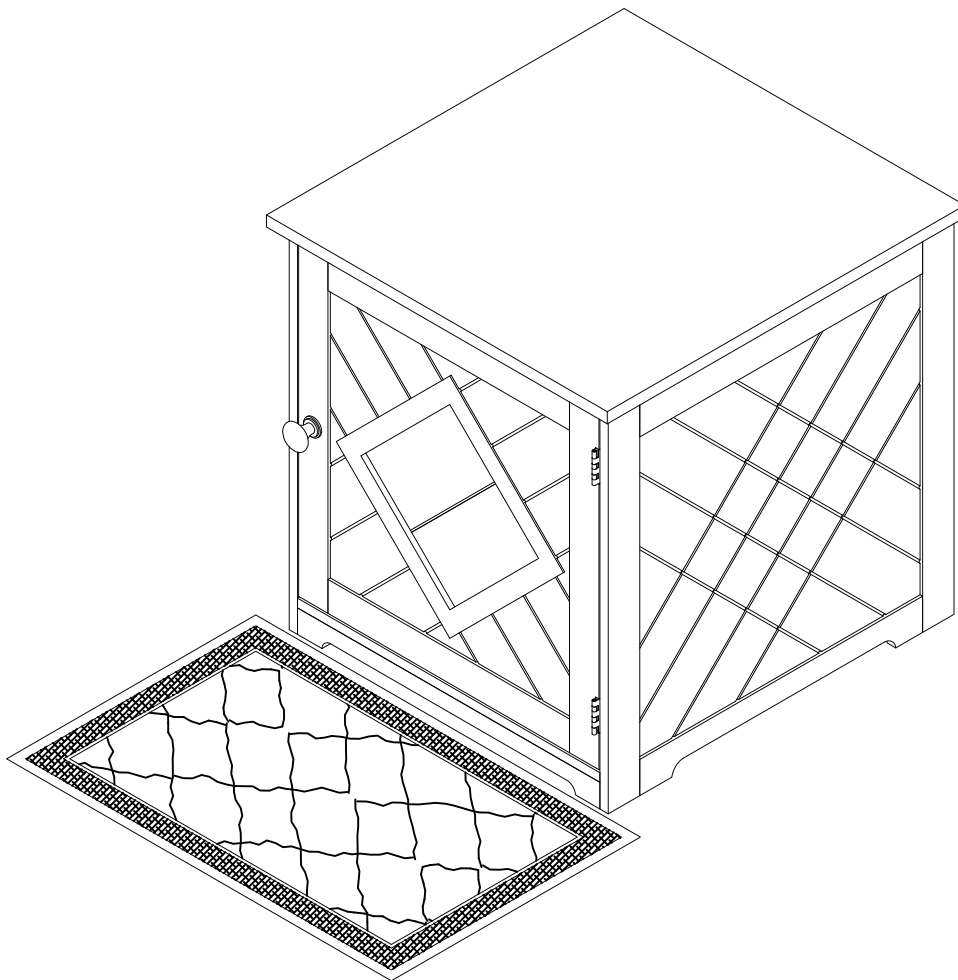

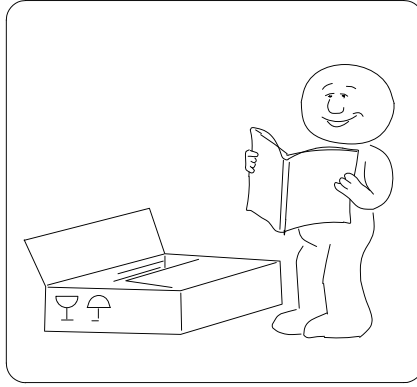
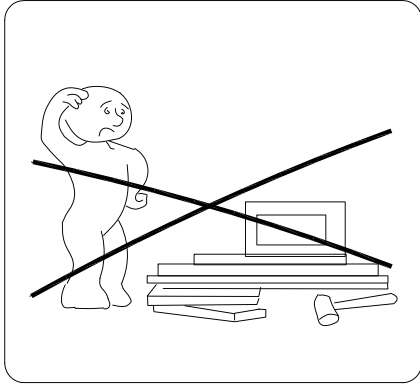

**! WARNING !**

1. PLEASE READ ALL INSTRUCTIONS CAREFULLY BEFORE STARTING ASSEMBLY.
2. DO NOT LET ANY SHARP OBJECTS TOUCH OR RUB THE SURFACE OF THE PRODUCT.
3. WHEN ASSEMBLING, DO NOT LET CHILDREN PLAY AROUND THE WORKING AREA.
4. PLEASE CONFIRM ALL PARTS ARE CORRECT BEFORE STARTING THE ASSEMBLY PROCESS.
5. DO NOT TIGHTEN ALL BOLTS AND SCREWS COMPLETELY UNTIL THE ENTIRE UNIT HAS BEEN ASSEMBLED AND SET UP.

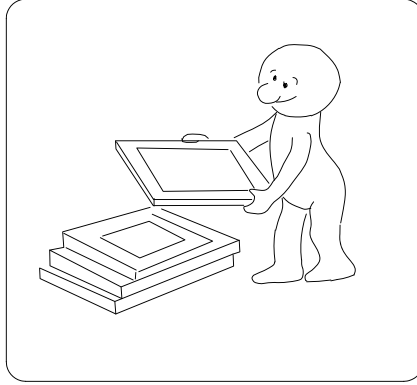
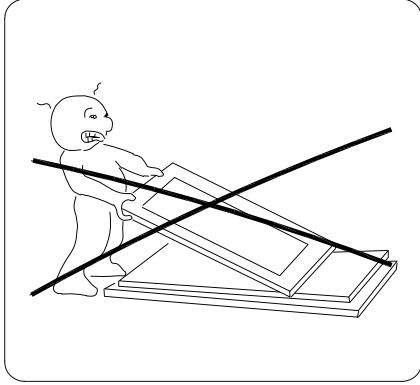

**ADVISE**

1. DO NOT SIT OR STAND ON THIS PRODUCT. IT IS INTENDED FOR PETS ONLY.
2. THIS PRODUCT SHOULD BE ASSEMBLED BY AN ADULT.
3. PLEASE PUT THE PRODUCT ON A SMOOTH SURFACE AFTER YOU ASSEMBLED IT.
4. PLACE ALL PARTS ON A CLEAN AND SMOOTH SURFACE SUCH AS A RUG OR CARPET TO AVOID THE PARTS FROM BEING SCRATCHED.
5. THE SCREW OF HINGE ON THE DOOR ALSO CAN BE ADJUSTABLE, TO MAKE IT EVEN THEN TIGHTEN ALL SCREWS.

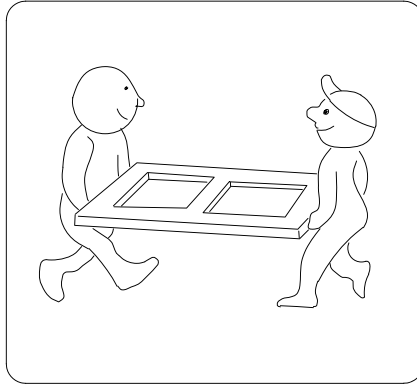
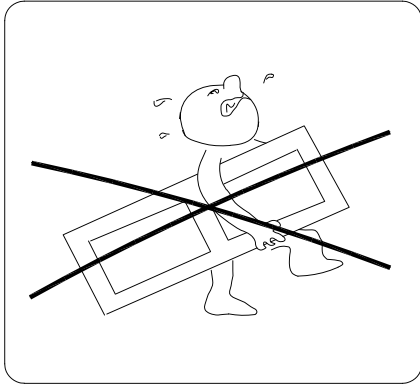

**TOOL NEEDED**

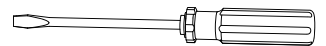
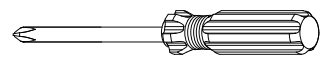
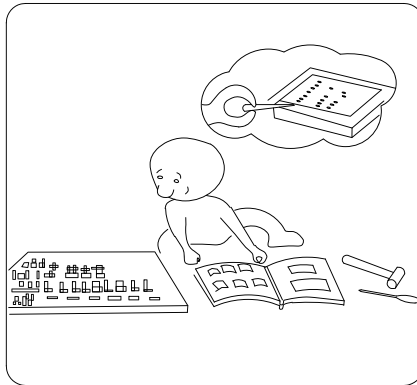
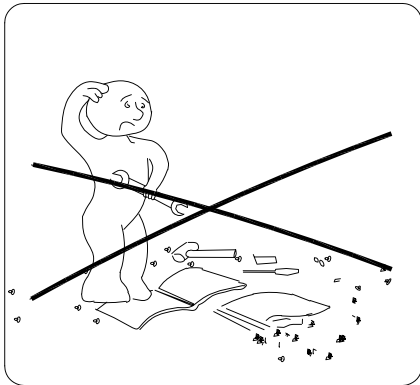

**SCREWDRIVER REQUIRED  
- NOT INCLUDED**

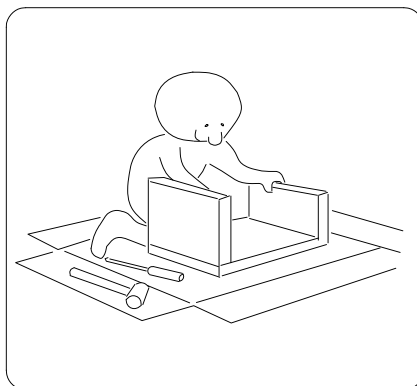
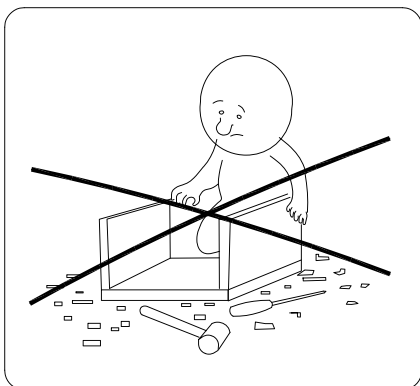

# PARTS

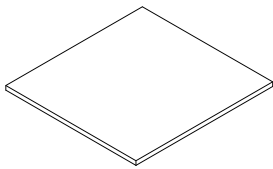
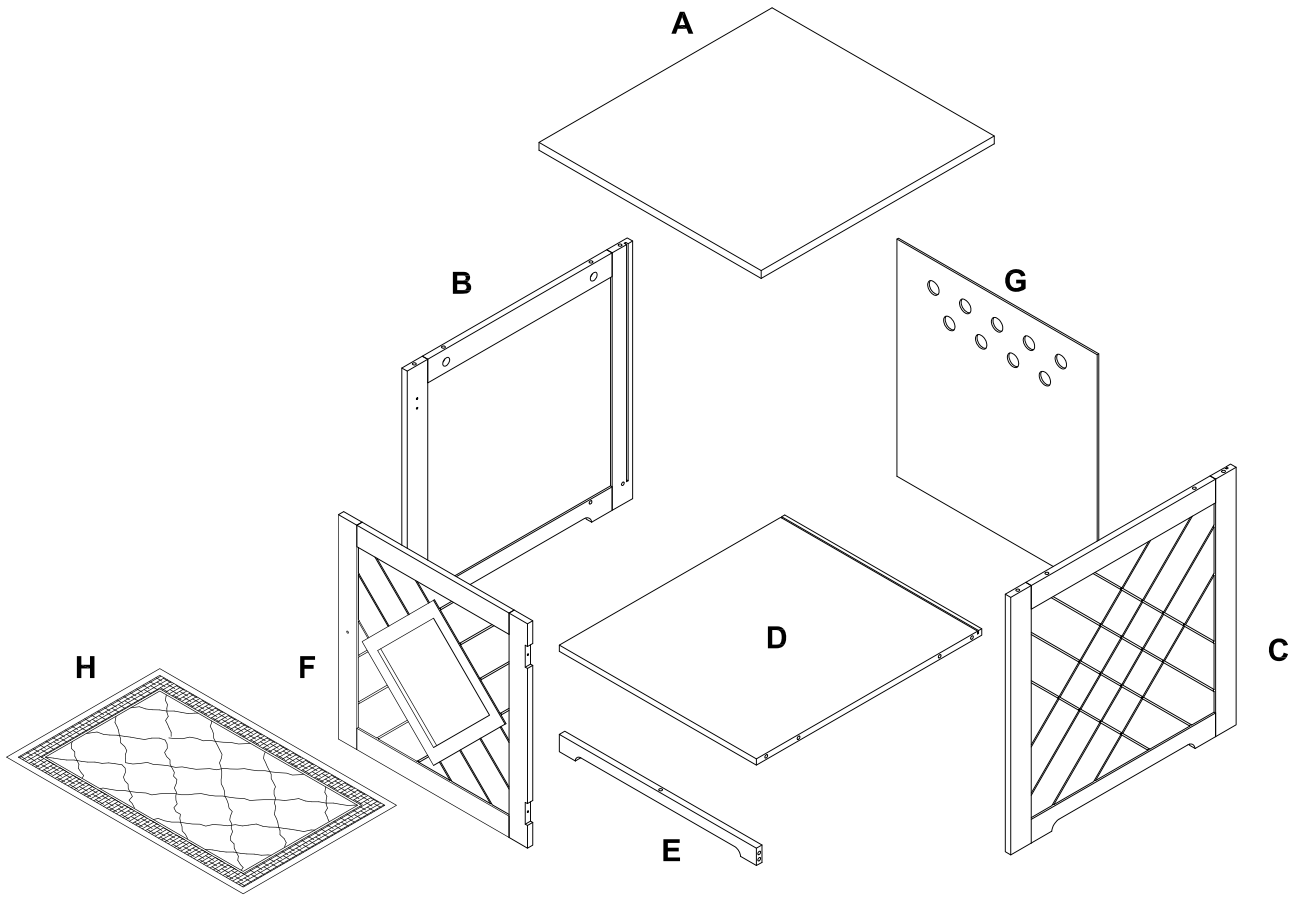

**A**  
Top Panel  
x1

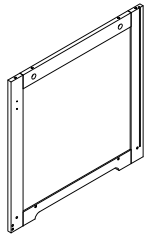

**B**  
Left Side Panel  
x1

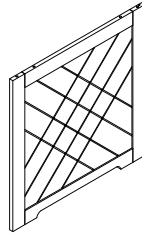

**C**  
Right Side Panel  
x1

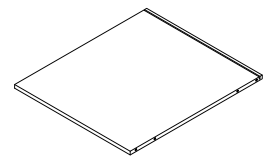

**D**  
Bottom Panel  
x1

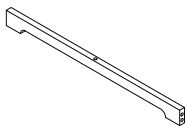

**E**  
Front Apron  
x1

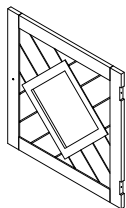

**F**  
Door Panel  
x1

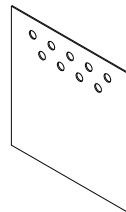

**G**  
Back Panel  
x1

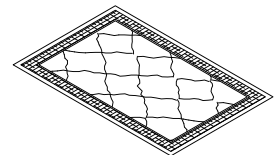

**H**  
PVC Pad  
x1

# HARDWARE

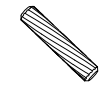

1  
x 12 pcs



2  
x 2 pcs

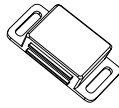

3  
x 1 pc

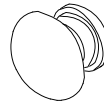

4  
x 1 pc



5  
x 1 pc



6  
x 8 pcs



7  
x 8 pcs

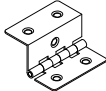

8  
x 2 pcs



9  
x 1 pcs



10  
x 10 pcs



11  
x 4 pcs



12  
x 4 pcs

# ASSEMBLY INSTRUCTIONS

1



2  
x 2 pcs



3  
x 1 pc

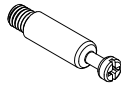

6  
x 4 pcs



1  
x 8 pcs

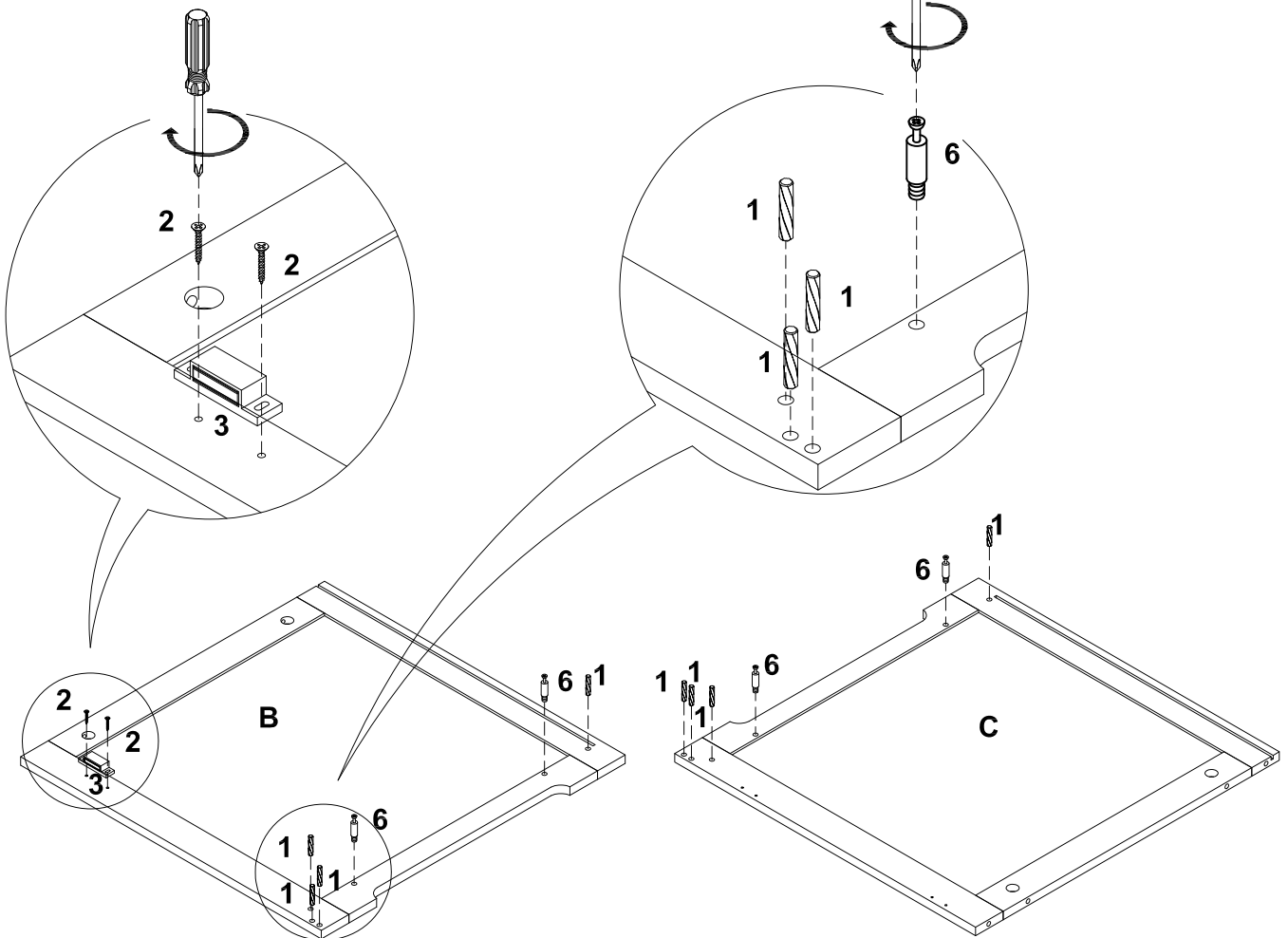

## STEP 1:

1. Install the magnet 3 to left side panel B, tighten them with screw 2.
2. Insert the wooden dowel 1 and tighten pin 6 into the hole of left and right side panel B & C.

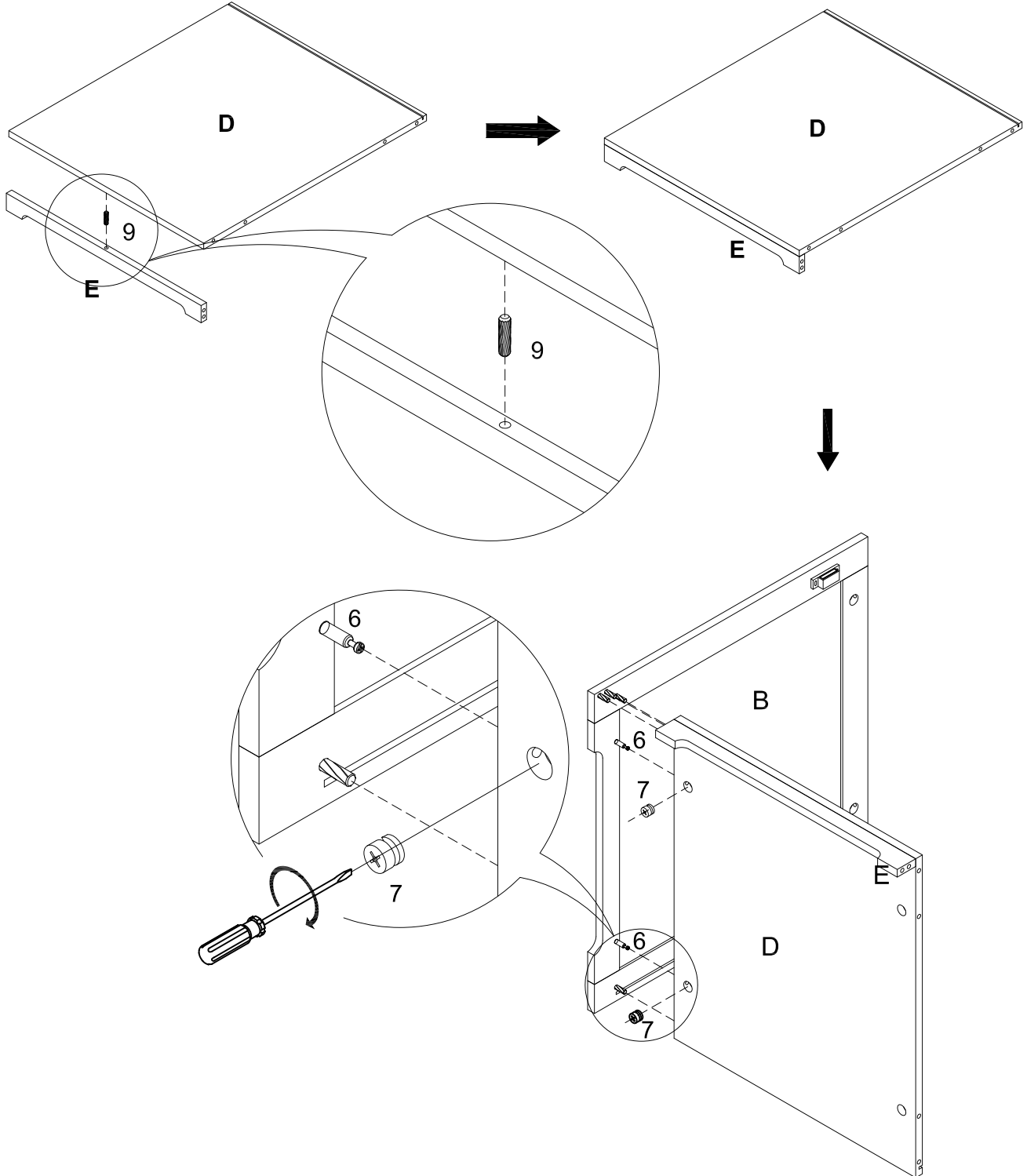
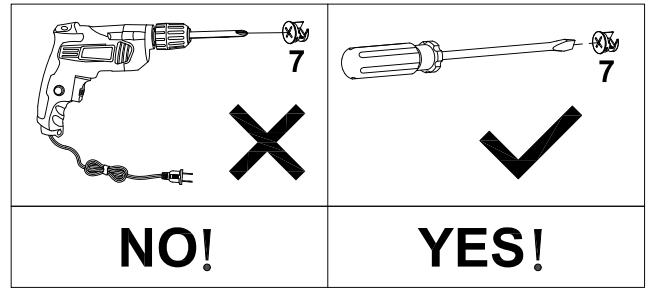
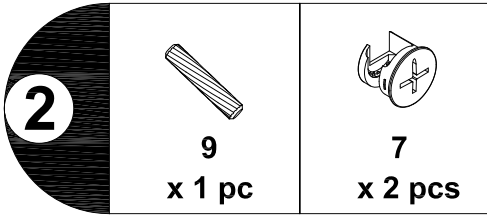

**STEP 2:**

1. Insert the wooden dowel 9 into front apron E and bottom panel D.
2. Connect bottom panel D & front apron E to left side panel B, insert cam lock 7 into the hole of bottom panel D, tighten cam lock 7 to the pin 6.

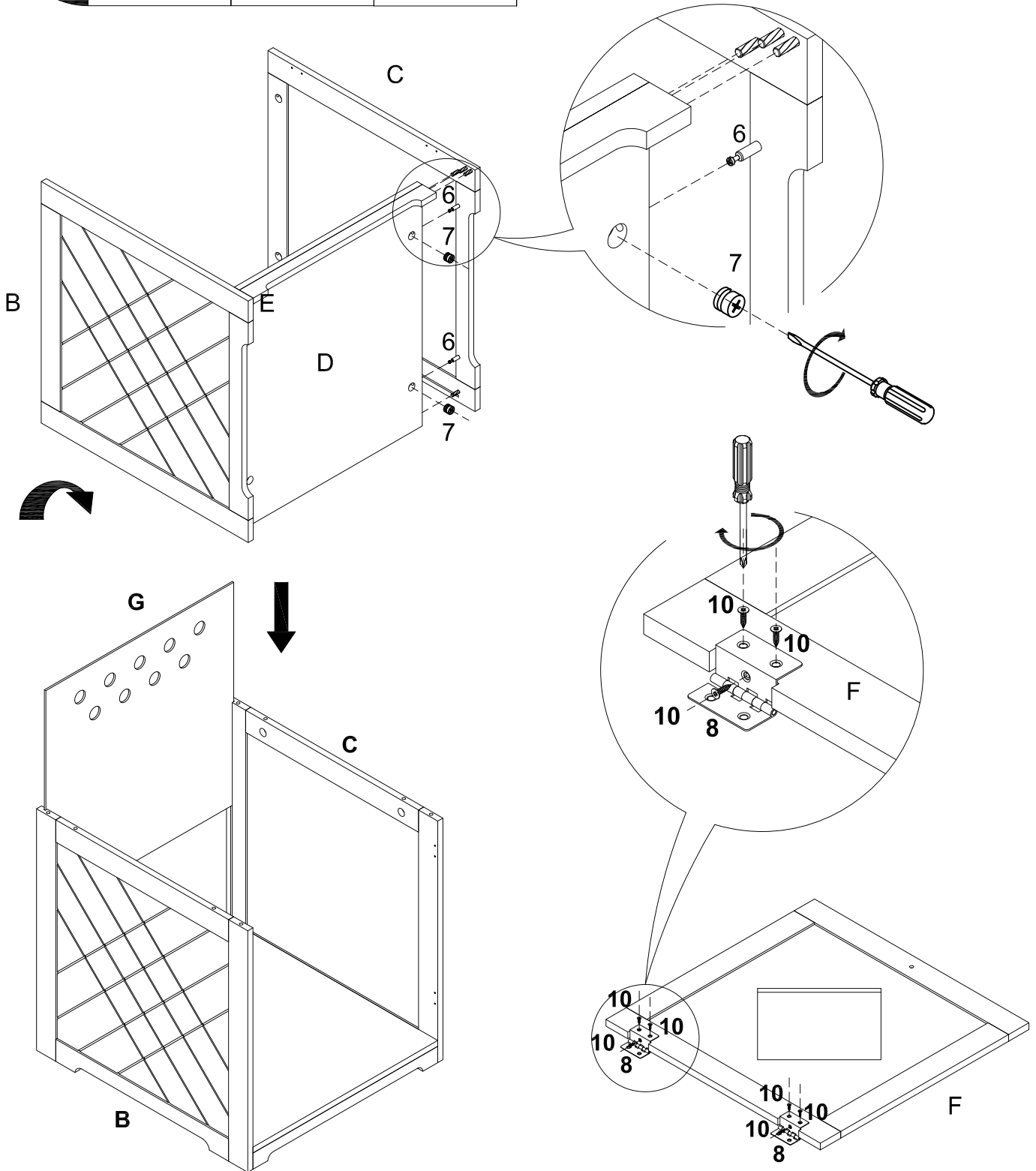
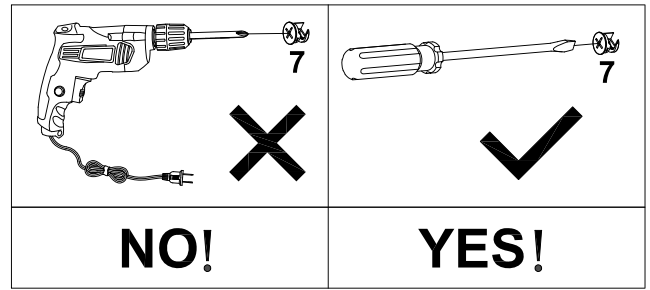
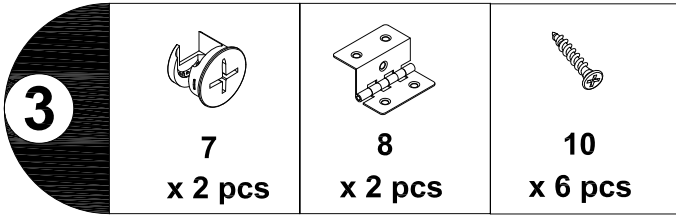

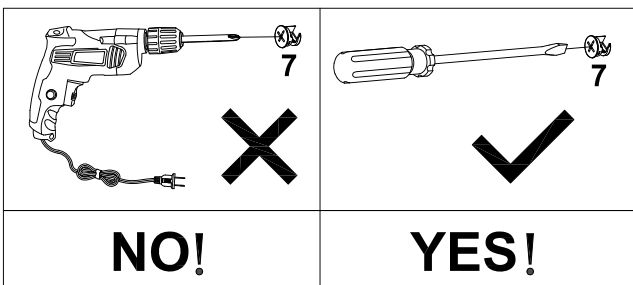
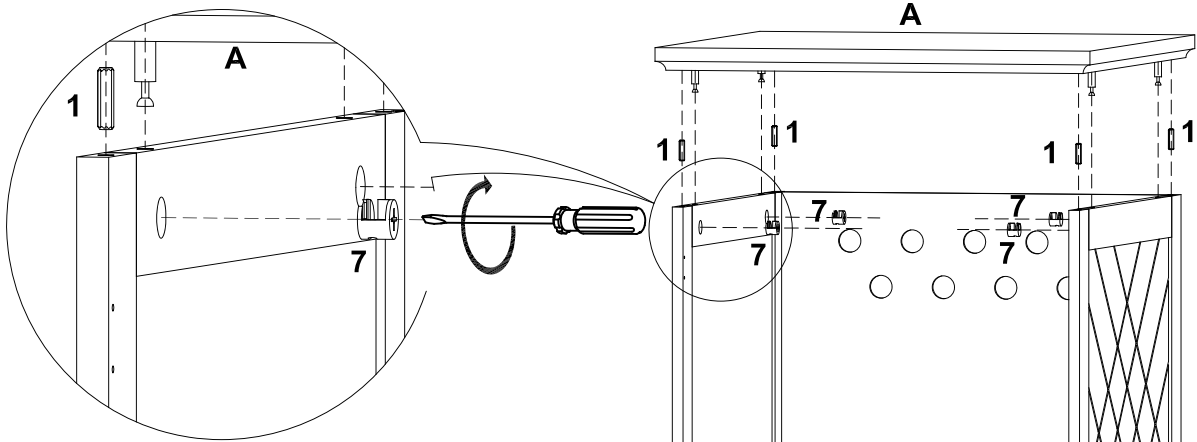
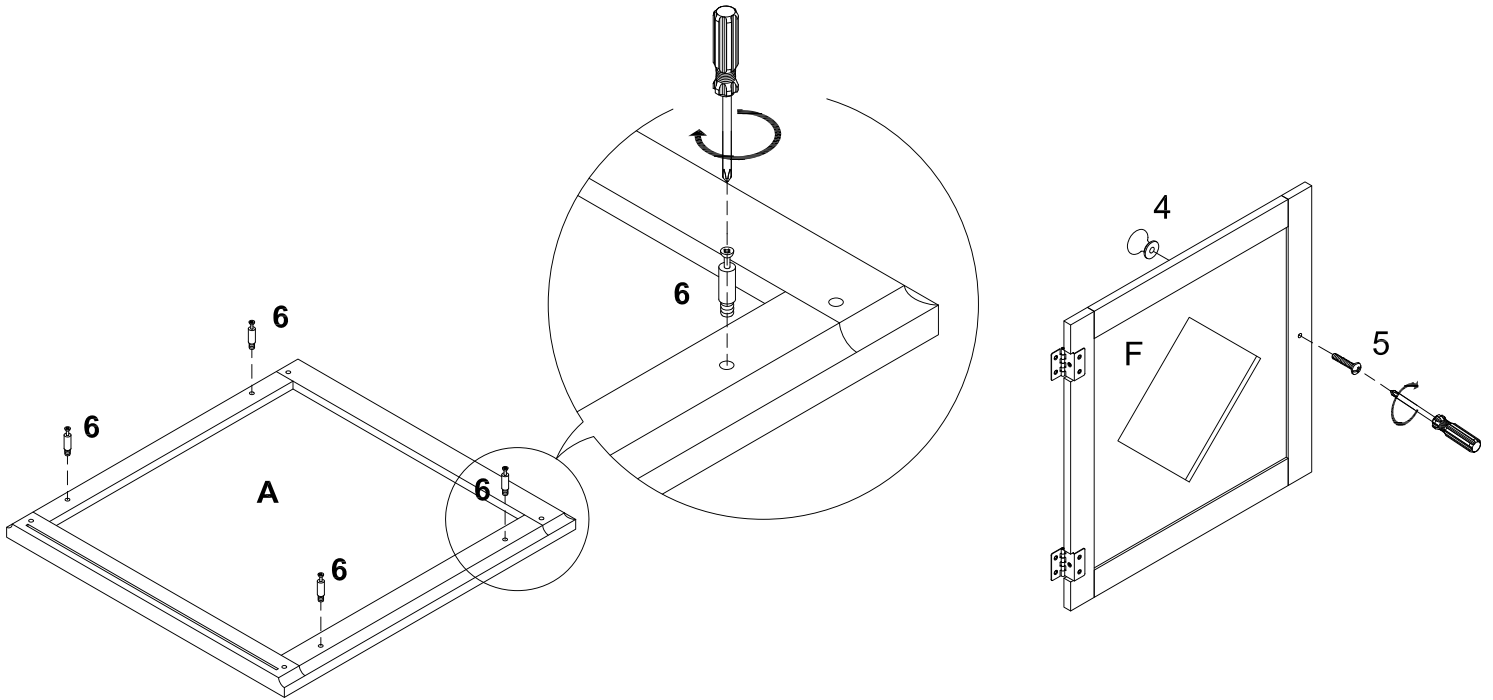
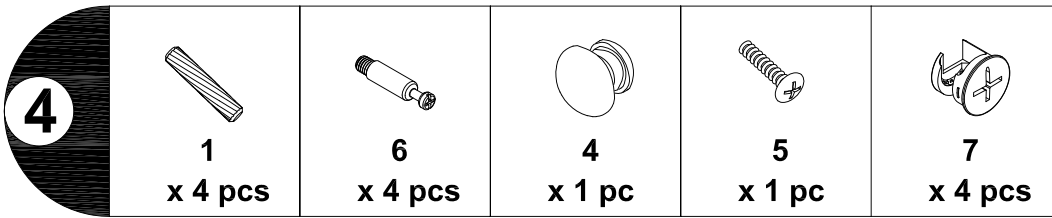

**STEP 3:**

1. Connect right side panel C to bottom panel D & front apron E, insert cam lock 7 into the hole of bottom panel D, tighten cam lock 7 to pin 6.
2. Insert the back panel G into left and right side panel B and C.
3. Install hinge 8 onto door panel F by screw 10.



**STEP 4:**

1. Tighten pin 6 into top panel A.
2. Assemble the knob 4 with screw 5 to door panel F.
3. Insert wooden dowel 1 into left and right side panel.
4. Assemble the top panel A, insert cam lock 7 into left and right side panel and tighten them.

<b>5</b>	 <b>10</b> x 4 pcs	 <b>11</b> x 4 pcs	 <b>12</b> x 4 pcs

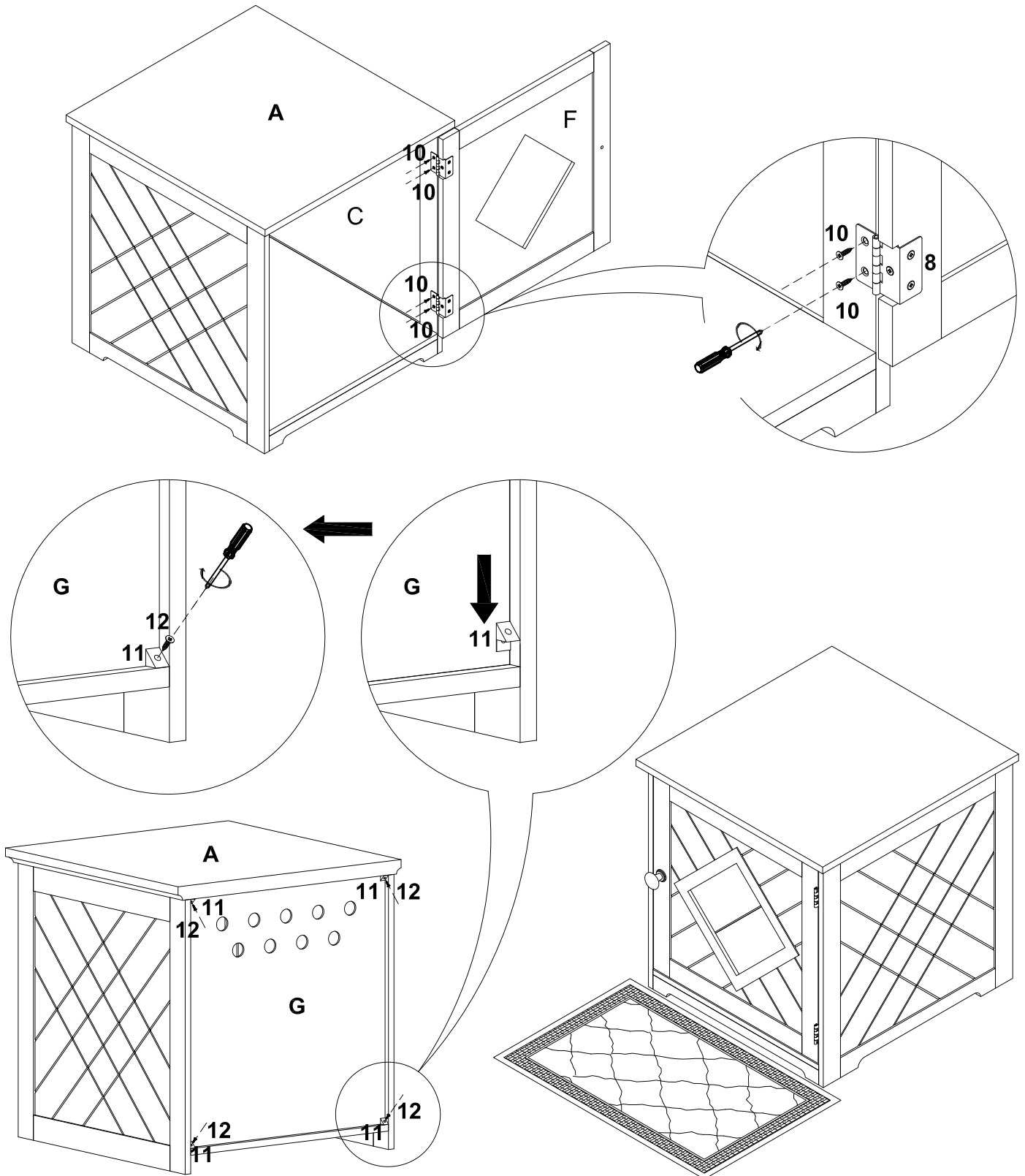

**STEP 5:**

1. Install the door panel F onto right side panel C, tighten screw 10 to hinge 8.
2. Insert part 11 to the four corner of back panel G, tighten screw 12 to part 11.
3. Put the PVC pad H in front of the house. Assembly complete.