

# Universe Home Inc

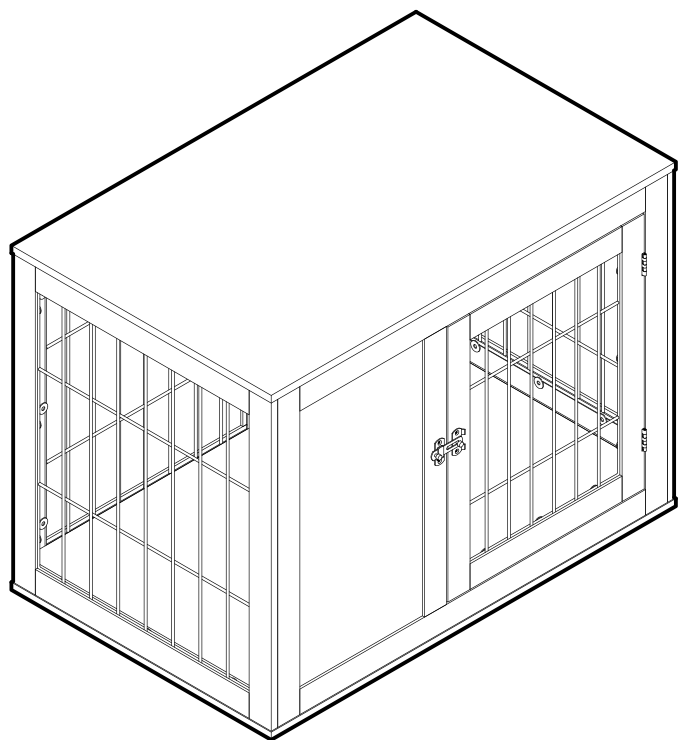

---

## ASSEMBLY AND CARE INSTRUCTION

### Dog Crate With Pet Cushion

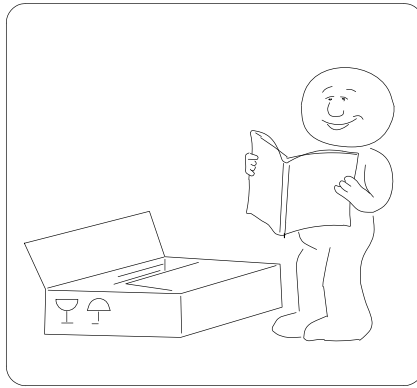
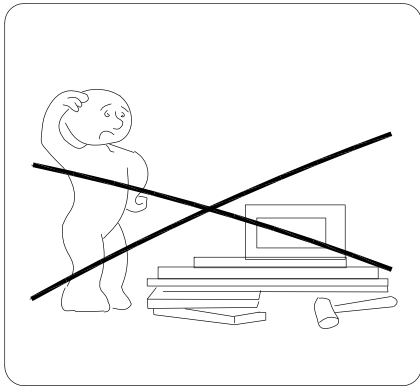

## **WARNING**



1. PLEASE READ ALL INSTRUCTIONS CAREFULLY BEFORE STARTING ASSEMBLY.
2. DO NOT LET ANY SHARP OBJECTS TOUCH OR RUB THE SURFACE OF THE PRODUCT.
3. WHEN ASSEMBLING, DO NOT LET CHILDREN PLAY AROUND THE WORKING AREA.
4. PLEASE CONFIRM ALL PARTS ARE CORRECT BEFORE STARTING THE ASSEMBLY PROCESS.
5. DO NOT TIGHTEN ALL BOLTS AND SCREWS COMPLETELY UNTIL THE ENTIRE UNIT HAS BEEN ASSEMBLED AND SET UP.

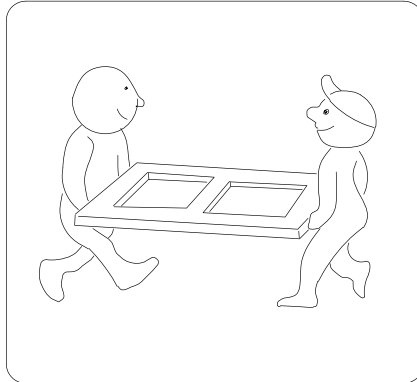
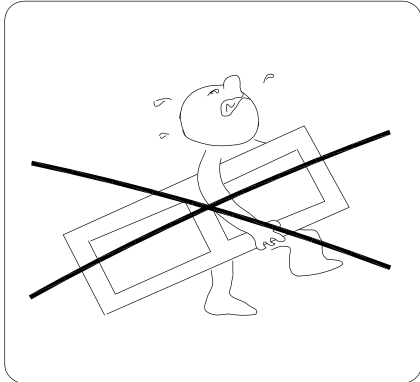
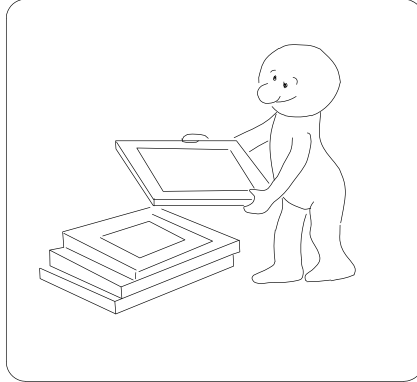
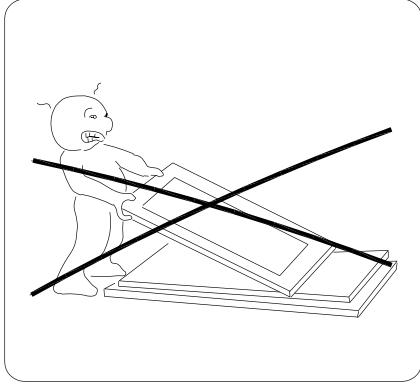

## **ADVISE**

1. DO NOT SIT OR STAND ON THIS PRODUCT. IT IS INTENDED FOR PETS ONLY.
2. THIS PRODUCT SHOULD BE ASSEMBLED BY AN ADULT.
3. PLEASE PUT THE PRODUCT ON A SMOOTH SURFACE AFTER YOU ASSEMBLED IT.
4. PLACE ALL PARTS ON A CLEAN AND SMOOTH SURFACE SUCH AS A RUG OR CARPET TO AVOID THE PARTS FROM BEING SCRATCHED.
5. THE SCREW OF HINGE ON THE DOOR ALSO CAN BE ADJUSTABLE, TO MAKE IT EVEN THEN TIGHTEN ALL SCREWS.

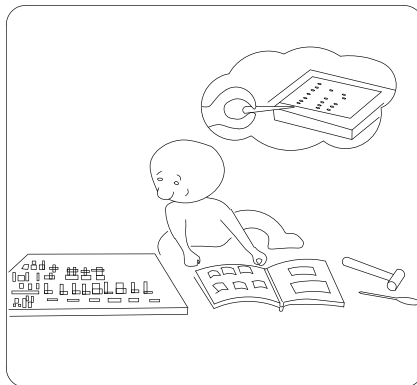
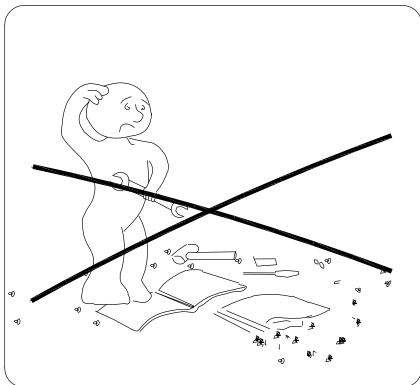

## **TOOL NEEDED**

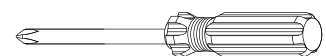
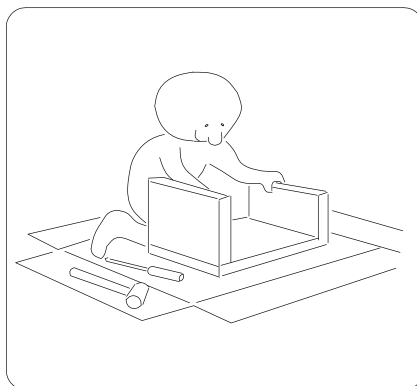
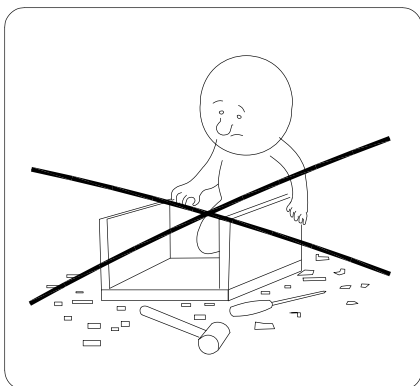

**SCREWDRIVER REQUIRED  
- NOT INCLUDED**

**PARTS**

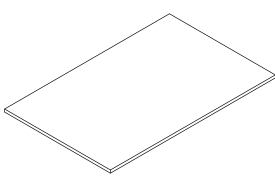
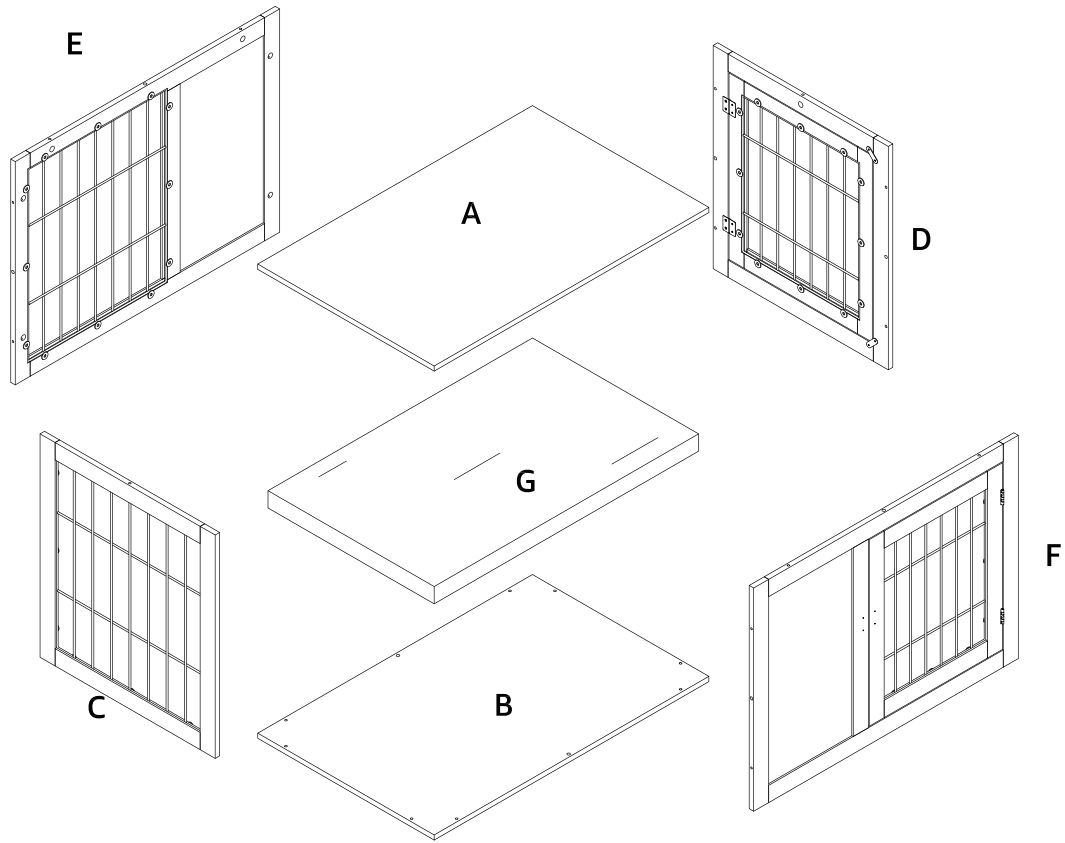

**A**  
Top Panel  
x1

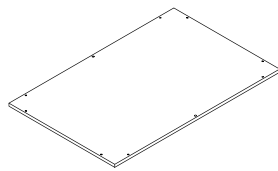

**B**  
Bottom Panel  
x1

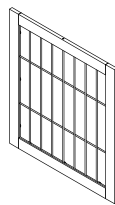

**C**  
Side Frame  
x1

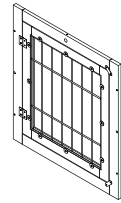

**D**  
Side Frame With Door  
x1

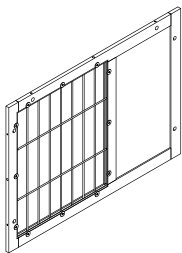

**E**  
Back Panel  
x1

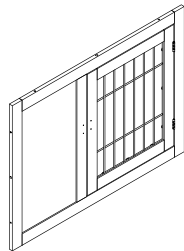

**F**  
Front Panel  
x1

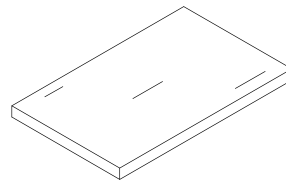

**G**  
Cushion  
x1

# HARDWARE



1

x 8 pcs



2

x 10 pcs



3

x 14 pcs



4

x 14 pcs



5

x 2 pcs



6

x 8 pcs





7

x 1 pc

# ASSEMBLY INSTRUCTIONS

1 Install the locker 5 into side frame with door D and front panel F, tighten locker 5 with screw 6.

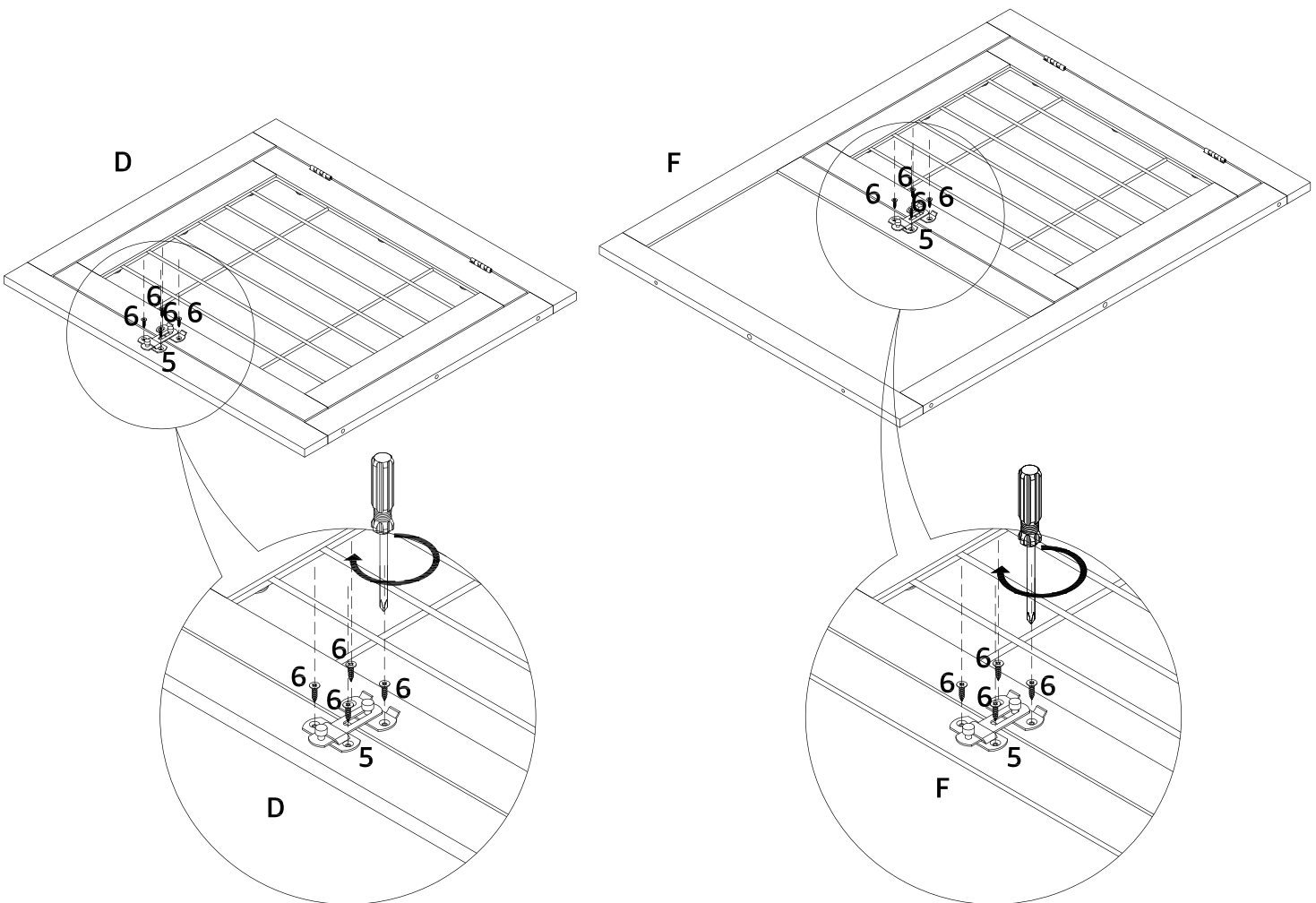

	
5	6
x 2 pcs	x 8 pcs



2

Tighten pin 4 and insert wooden dowel 2 into the side frame C and side frame with door D.



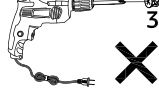
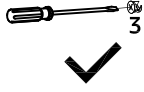

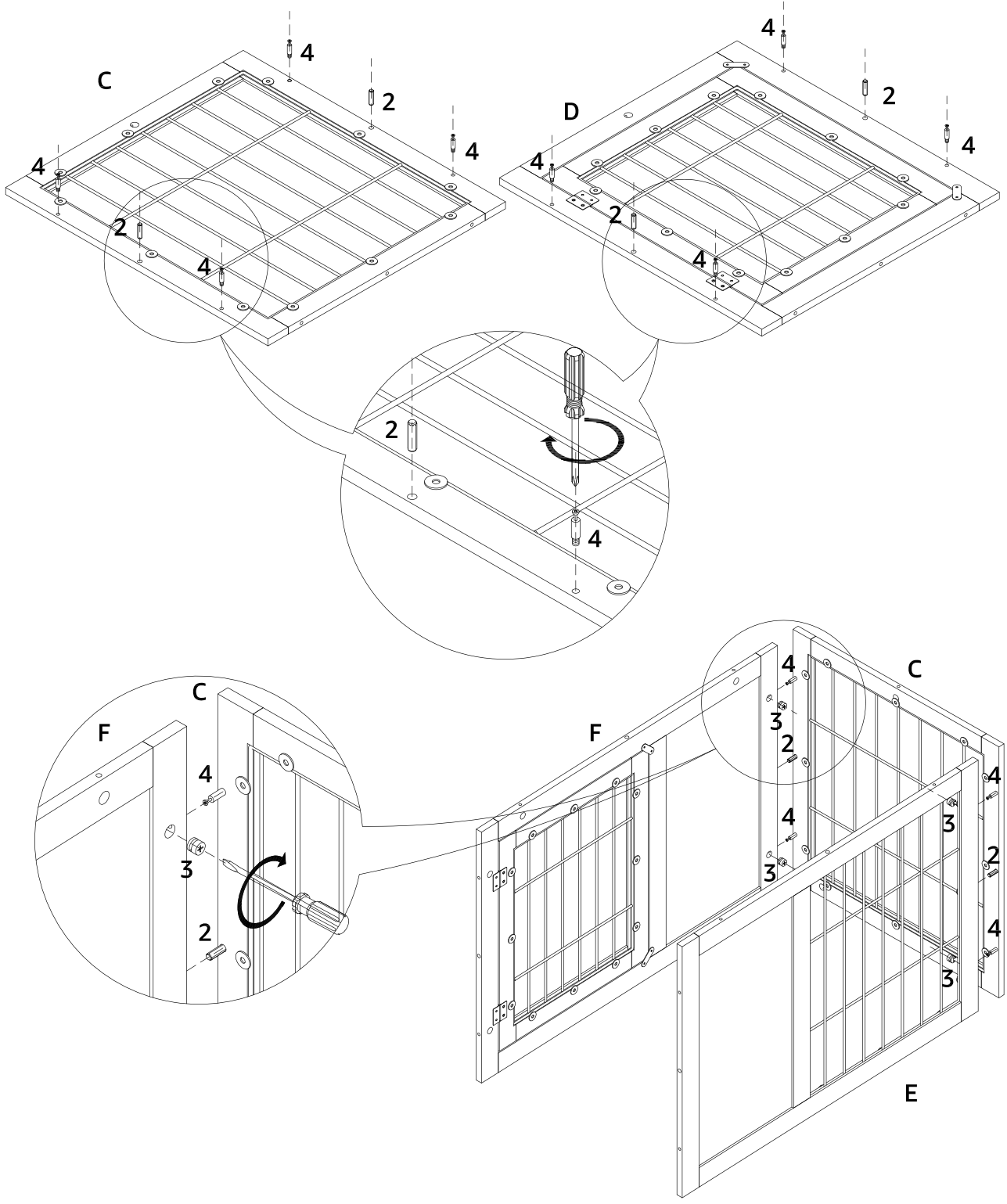
Connect front panel F and back panel E with side panel C, insert cam lock 3 into the hole on both front panel F and back panel E, tighten cam lock 3 to pin 4.

 4 x 8 pcs	 2 x 4 pcs	 3 x 4 pcs	 X NO!	 ✓ YES!
---	---	--	---	--



3

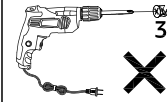
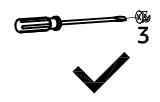

Connect side frame with door D to front panel F and back panel E, insert cam lock 3 into the hole on both front panel F and back panel E, tighten cam lock 3 to pin 4. Turn upside down, insert four wooden dowel 2 into front panel F, back panel E, side panel C and side panel with door D, input the bottom panel B to the body, tighten bolt 1 into the hole of bottom panel B by Allen Wrench 7.

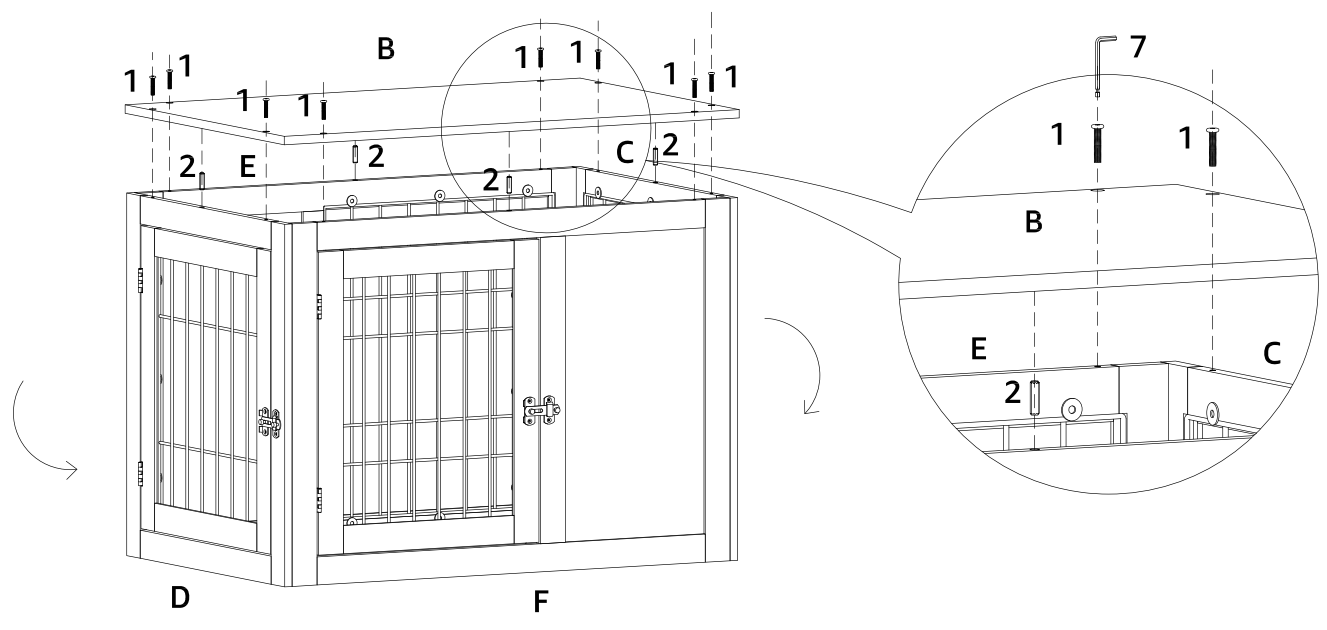
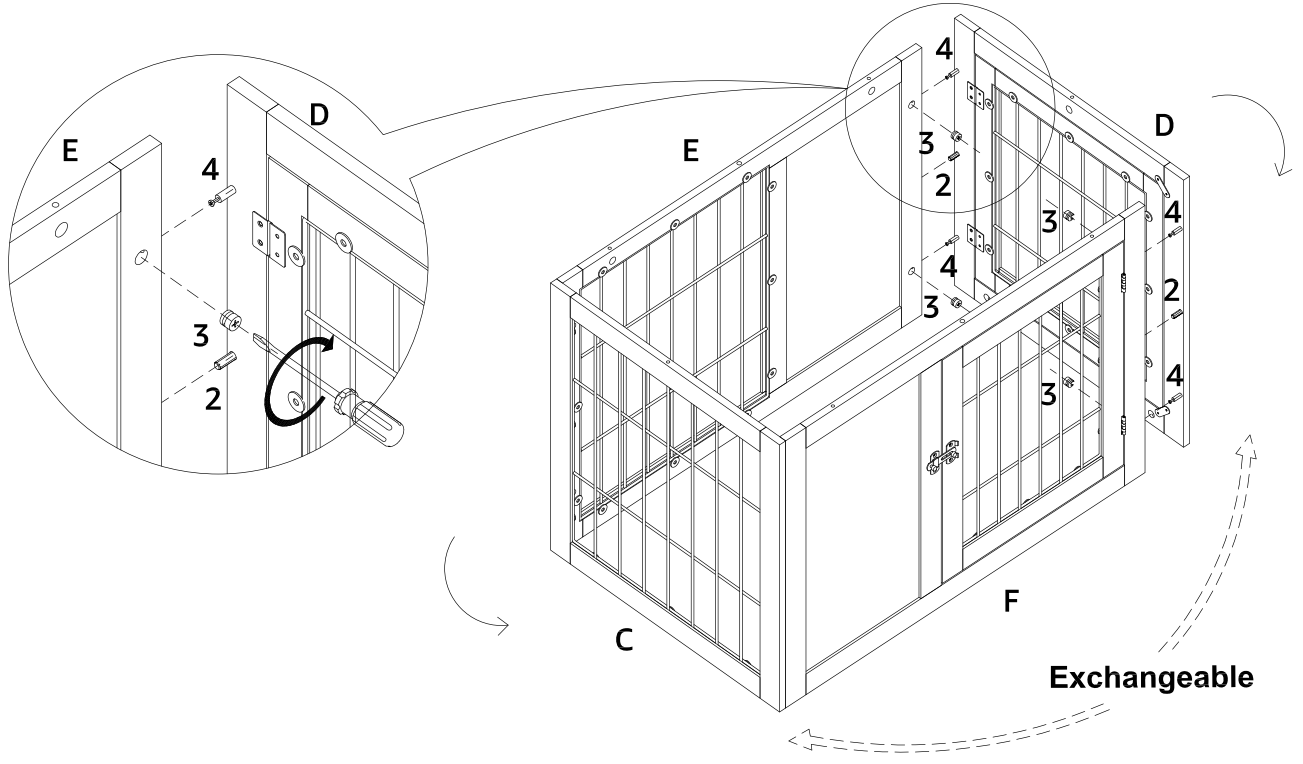
 1 x 8 pcs	 2 x 4 pcs	 3 x 4 pcs	 7 x 1 pc	 3 NO!	 3 YES!
---	---	---	---	---	--



4

Tighten pin 4 to top panel A, insert two wooden dowel 2 into front panel F and back panel E.  
 Input the top panel A to the body, tighten cam lock 3 into the hole on both front panel F, back panel E and side panel C and D.

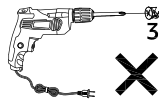
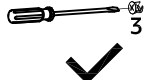
 <b>4</b> x 6 pcs	 <b>2</b> x 2 pcs	 <b>3</b> x 6 pcs	 <b>NO!</b>	 <b>YES!</b>
--	--	---	---	--

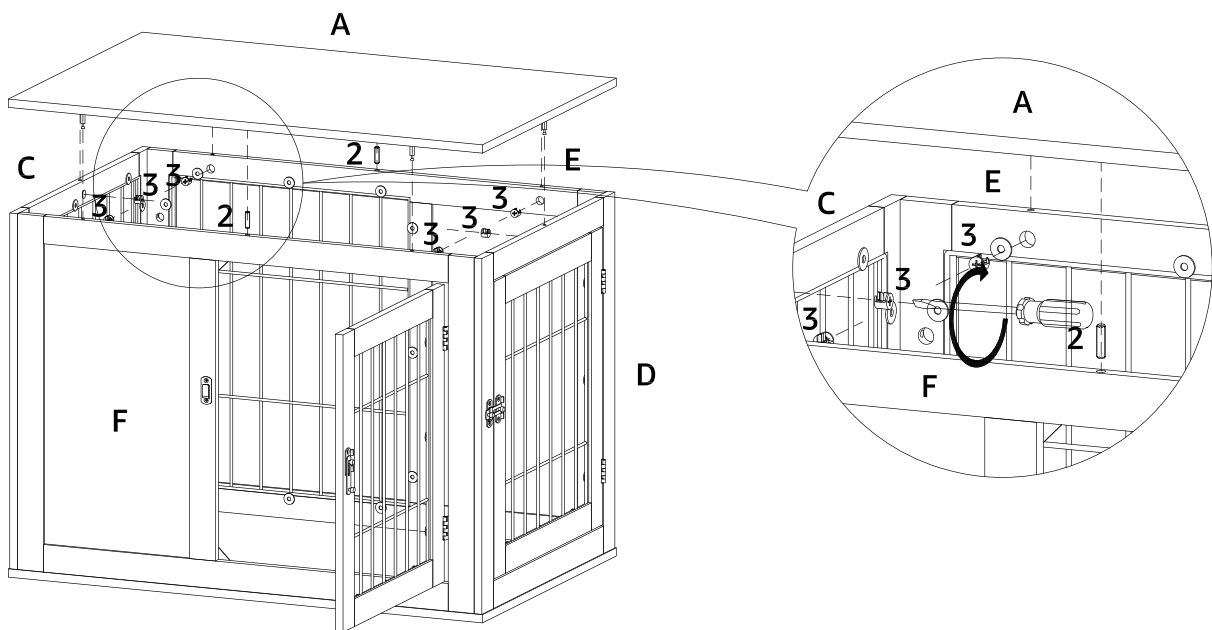
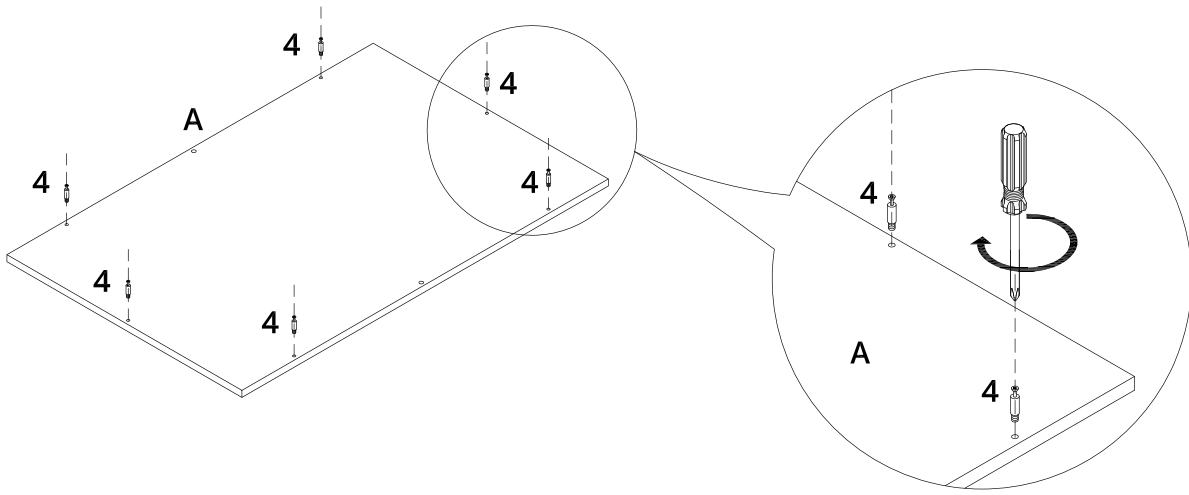

5 Input the cushion G into the crate.

