

UNIVERSE HOME INC

ASSEMBLY AND CARE INSTRUCTION

Cat Litter Box

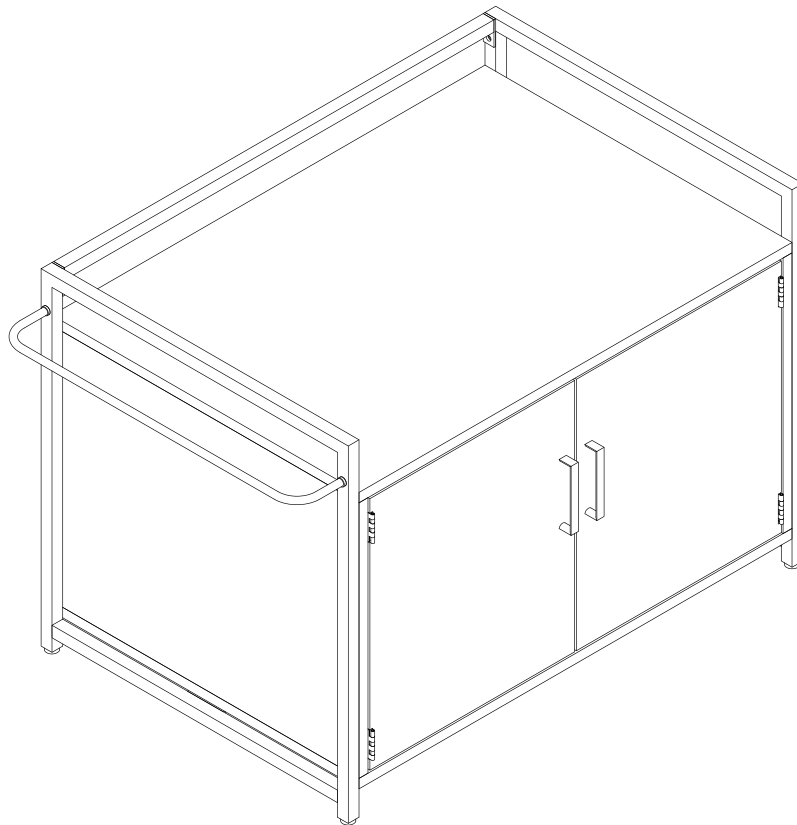

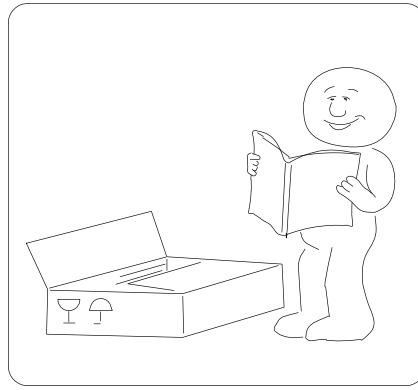
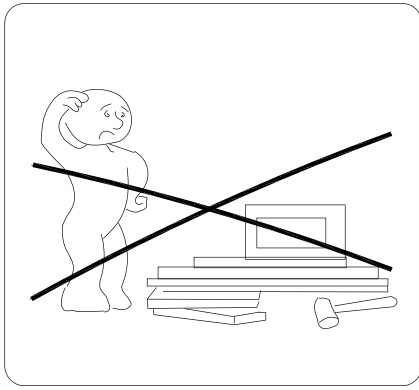

! WARNING !

1. PLEASE READ ALL INSTRUCTIONS CAREFULLY BEFORE STARTING ASSEMBLY.
2. DO NOT LET ANY SHARP OBJECTS TOUCH OR RUB THE SURFACE OF THE PRODUCT.
3. WHEN ASSEMBLING, DO NOT LET CHILDREN PLAY AROUND THE WORKING AREA.
4. PLEASE CONFIRM ALL PARTS ARE CORRECT BEFORE STARTING THE ASSEMBLY PROCESS.
5. DO NOT TIGHTEN ALL BOLTS AND SCREWS COMPLETELY UNTIL THE ENTIRE UNIT HAS BEEN ASSEMBLED AND SET UP.

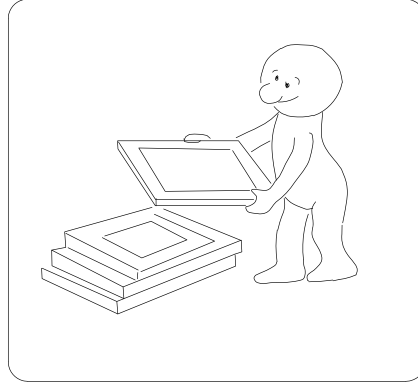
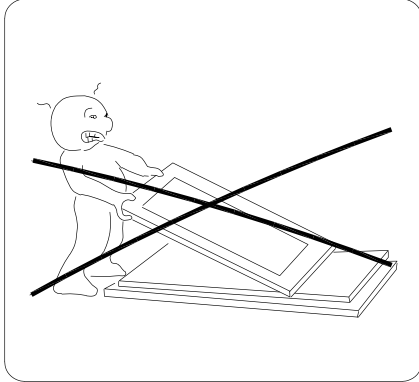

ADVISE

1. DO NOT SIT OR STAND ON THIS PRODUCT. IT IS INTENDED FOR PETS ONLY.
2. THIS PRODUCT SHOULD BE ASSEMBLED BY AN ADULT.
3. PLEASE PUT THE PRODUCT ON A SMOOTH SURFACE AFTER YOU ASSEMBLED IT.
4. PLACE ALL PARTS ON A CLEAN AND SMOOTH SURFACE SUCH AS A RUG OR CARPET TO AVOID THE PARTS FROM BEING SCRATCHED.
5. THE SCREW OF HINGE ON THE DOOR ALSO CAN BE ADJUSTABLE, TO MAKE IT EVEN THEN TIGHTEN ALL SCREWS.

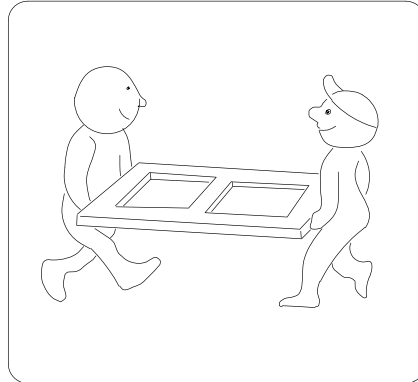
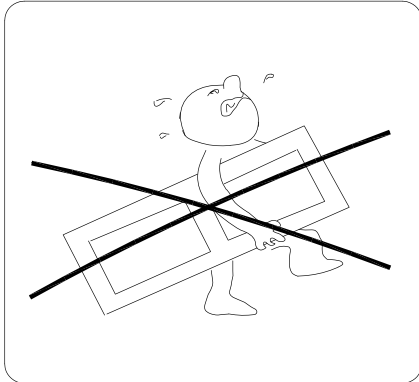

TOOLS NEEDED

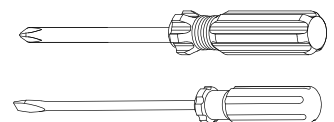

**SCREWDRIVER REQUIRED
- NOT INCLUDED**

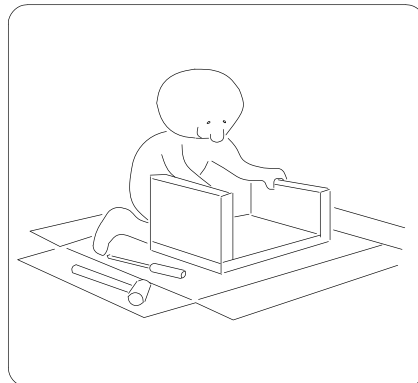
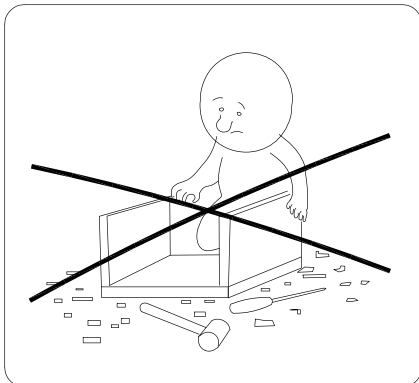
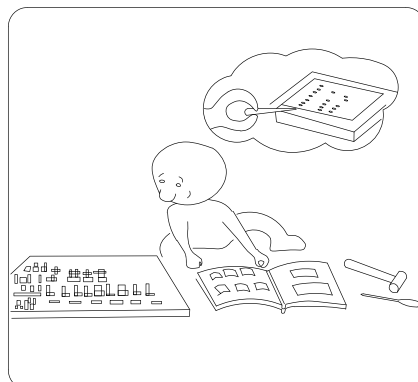
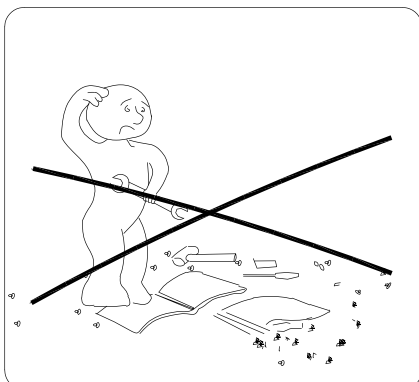

PARTS

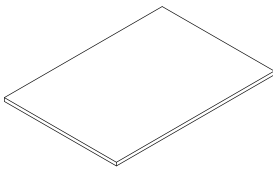
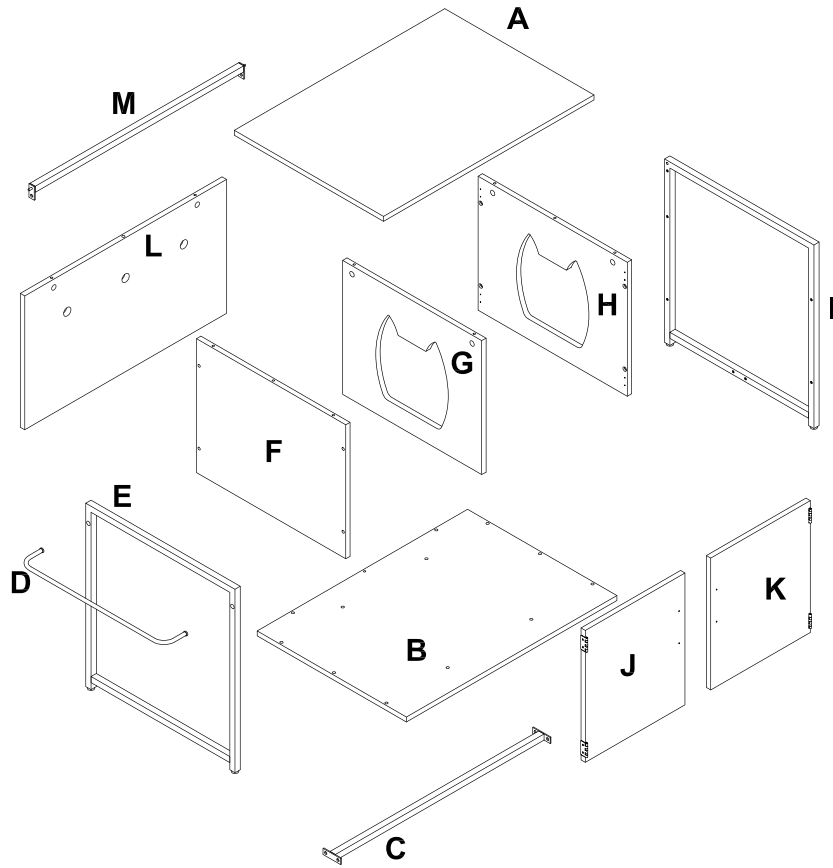

A
Top Panel
x1

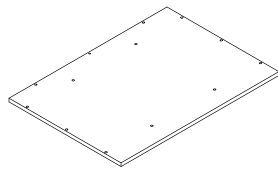

B
Bottom Panel
x1

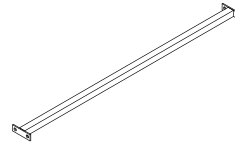

C
Bottom Cross Bar
x1

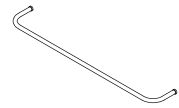

D
Towel Rack
x1

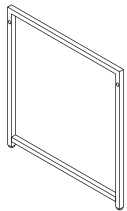

E
Left Side Frame
x1

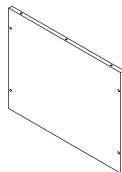

F
Side Panel
x1

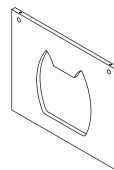

G
Divider Panel
x1

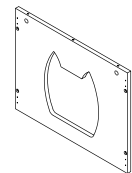

H
Side Panel
x1

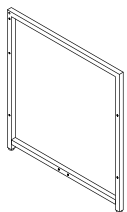

I
Right Side Frame
x1

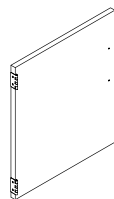

J
Left Door
x1

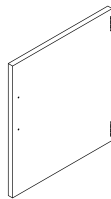

K
Right Door
x1

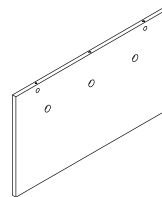



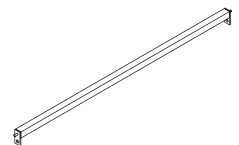







L
Back Panel
x1



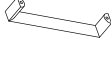

M
Top Bar
x1

HARDWARE

- | | | | | | |
|---|--|--|---|--|---|
| 
1
x 18 pcs | 
2
x 6 pcs | 
3
x 6 pcs | 
4
x 8 pcs | 
5
x 8 pcs | 
6
x 1 pc |
| 
7
x 2 pcs | 
8
x 2 pcs | 
9
x 4 pcs | 
10
x 8 pcs | 
11
x 1 pc | |

ASSEMBLY INSTRUCTIONS

1	 1 x 6 pcs	 3 x 2 pcs	 11 x 1pc
---	--	--	---

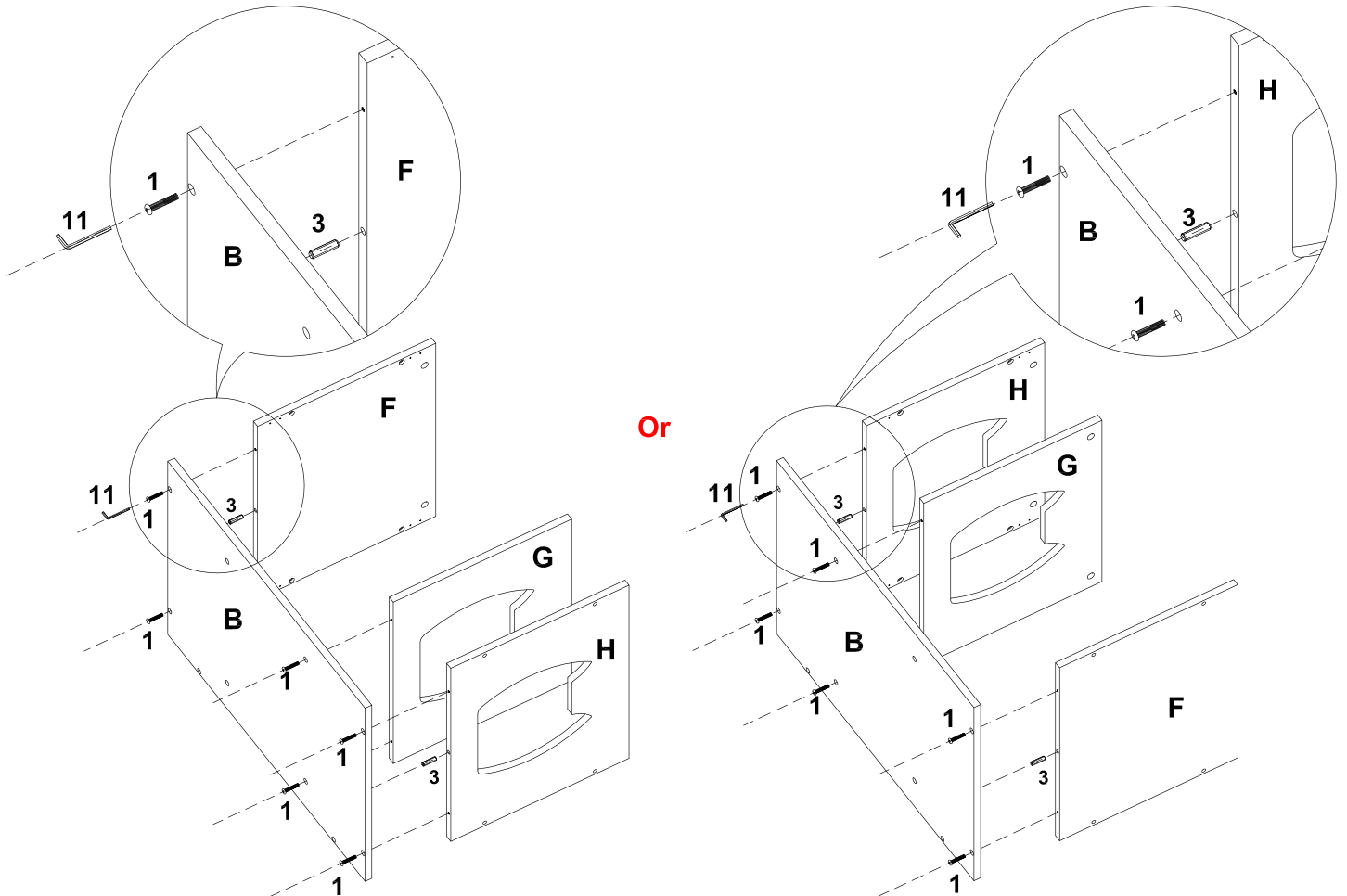

STEP 1:

1. Insert wood dowel # 3 into side panel F & H, connect side panel F, H and divider panel G with bottom panel B, tighten bolt # 1 by Allen Wrench # 11.

Remarks: Side panel F & H can be exchangeable, divider panel G can be changed according to the side panel.

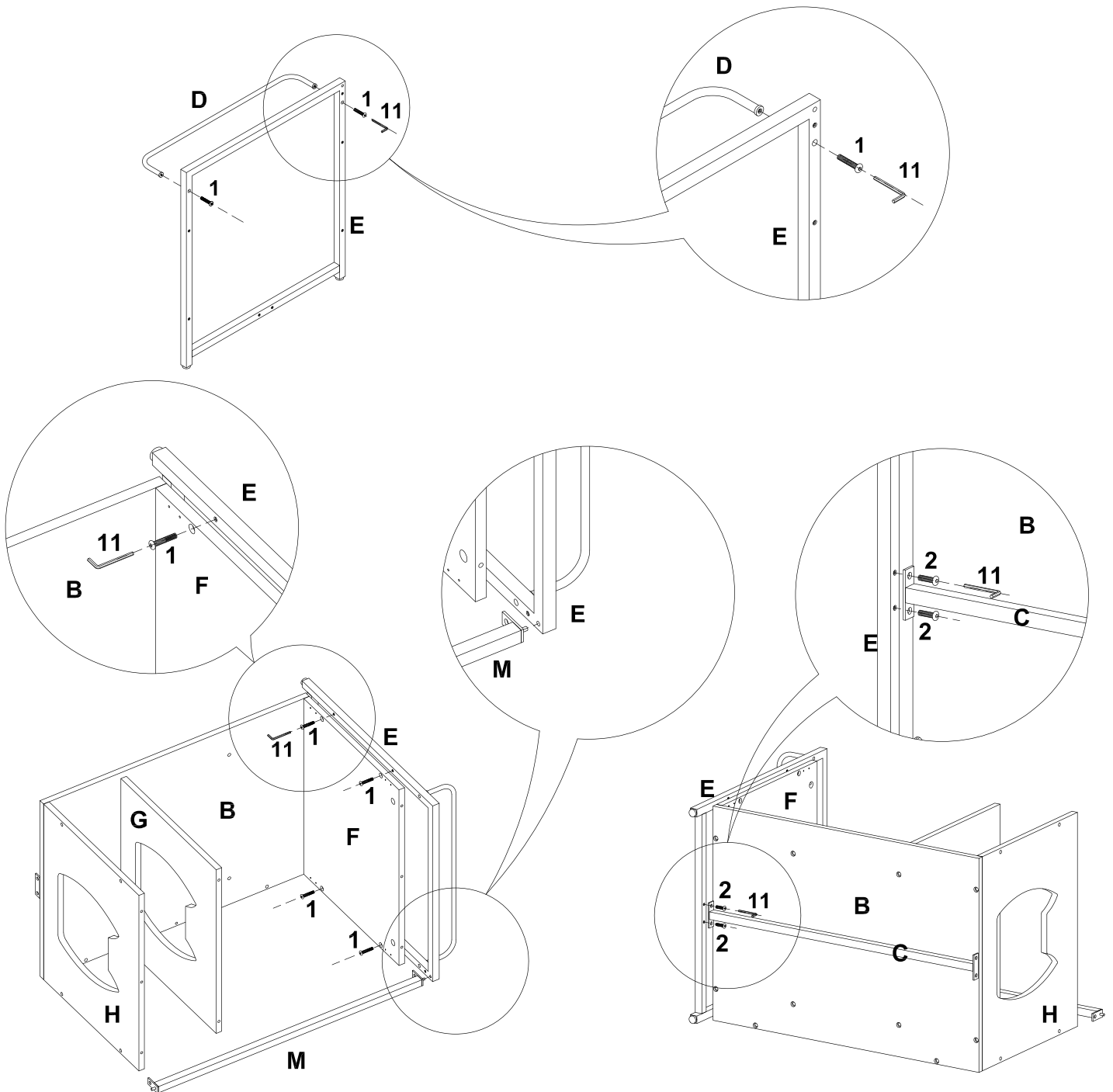
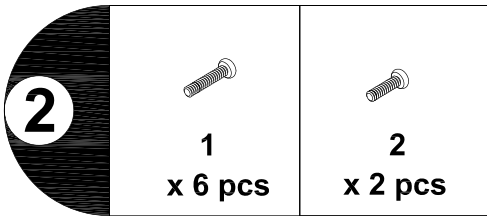

STEP 2:

1. Connect towel rack D with side frame E, tighten bolt # 1 by Allen Wrench # 11.
2. Connect side frame E to side panel F, tighten bolt # 1 by Allen Wrench # 11.
3. Insert top bar M to side frame E.
4. Connect bottom bar C to side frame E, tighten bolt # 2 to bottom bar C.

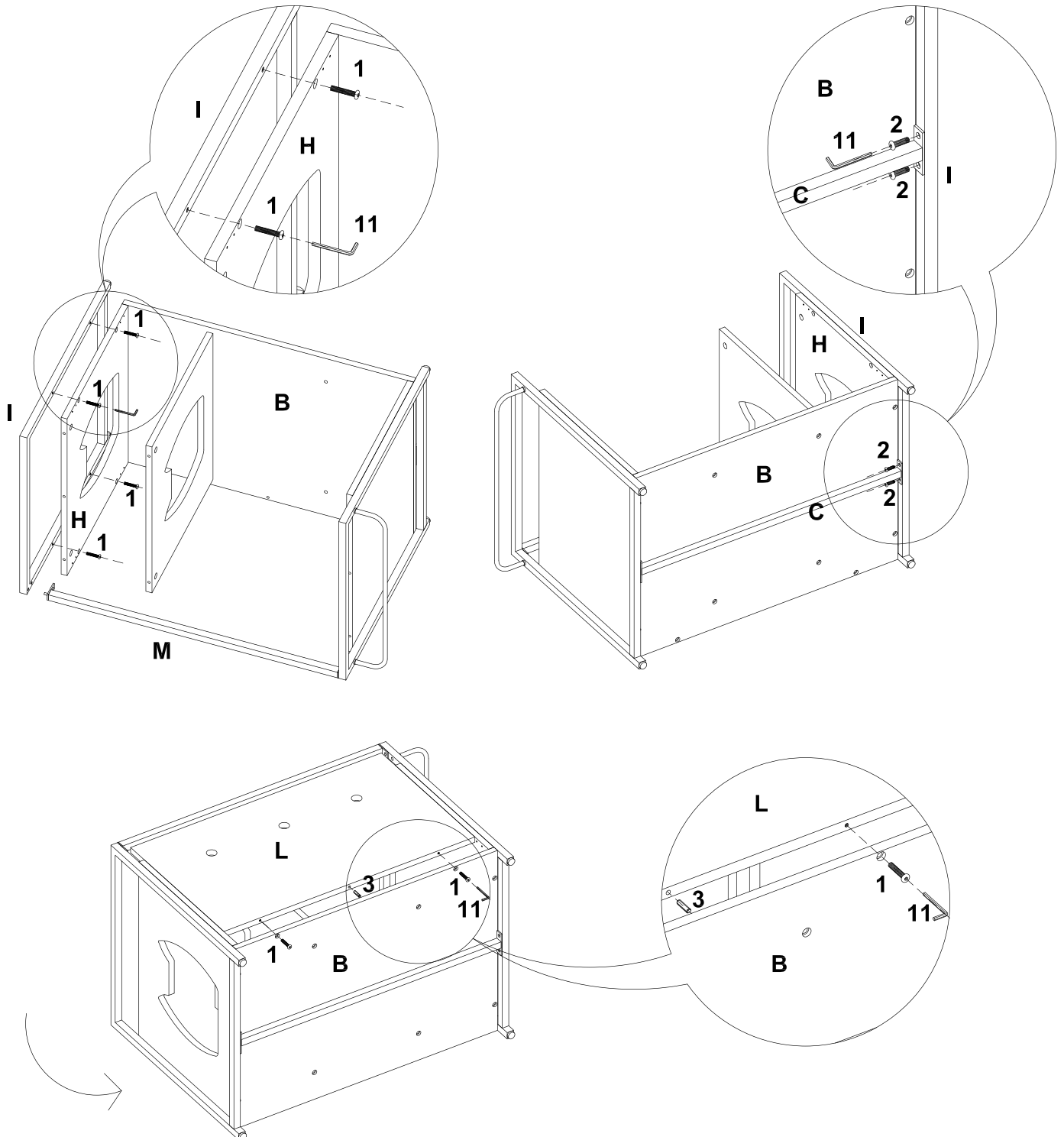
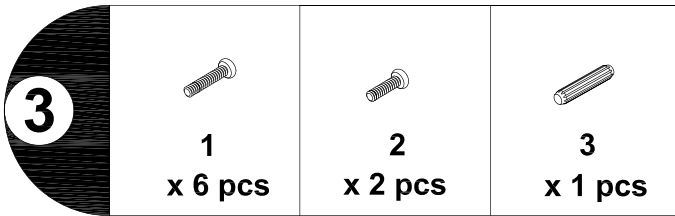

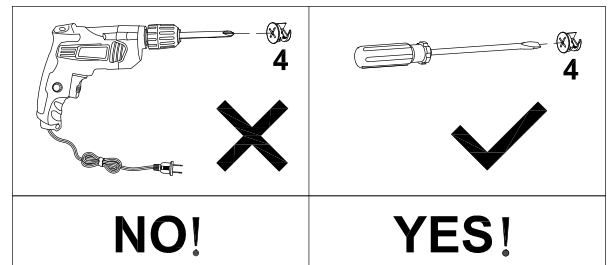
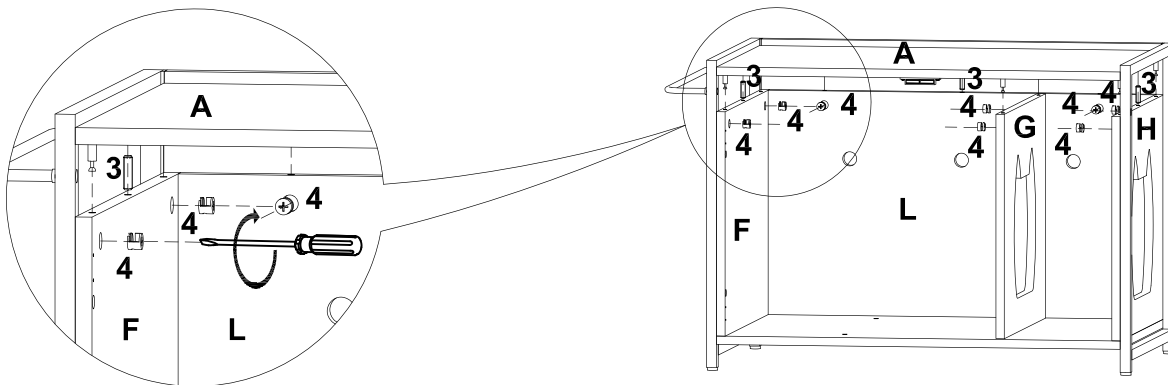
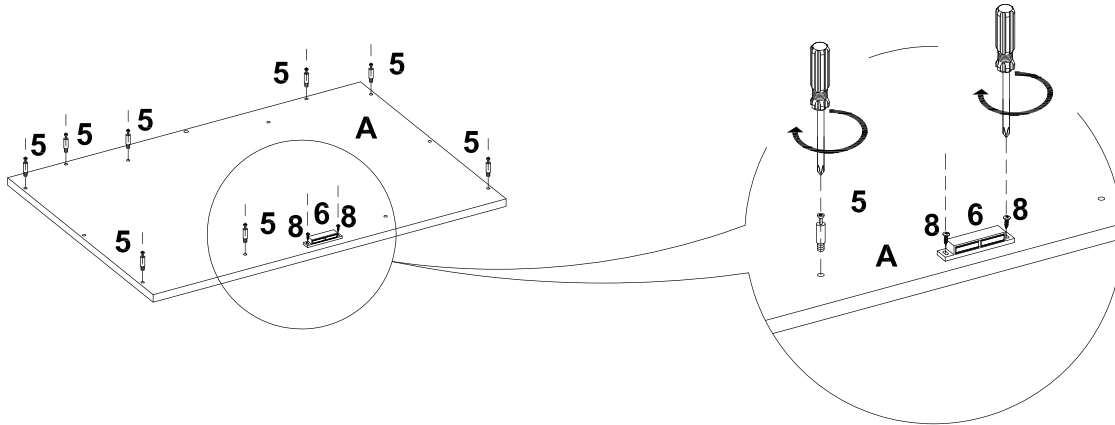
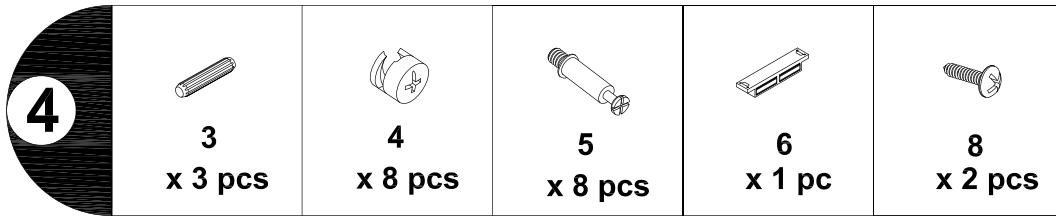

STEP 3:

1. Connect side frame I to side panel H and insert top bar M to side frame I at the meantime, tighten bolt # 1 by Allen Wrench # 11.
2. Tighten bolt # 2 to side frame I.
3. Insert wooden dowel # 3 to back panel L.
4. Input back panel L to side panel and bottom panel B, tighten bolt # 1 to back panel L and bottom panel B by Allen Wrench # 11.

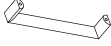

STEP 4:

1. Install the magnet # 6 to top panel A and tighten it with screw # 8.
2. Insert the pin # 5 into the hole of the top panel A then tighten pin # 5.
3. Insert wood dowel # 3 into side panel H and F and back panel L.
4. Put the top panel A onto the product, insert cam lock # 4 on the hole of side panel H & F, divider panel G and back panel L. Then tighten cam lock # 4 to pin # 5.

5				
	2 x 2 pcs	7 x 2 pcs	9 x 4 pcs	10 x 8 pcs

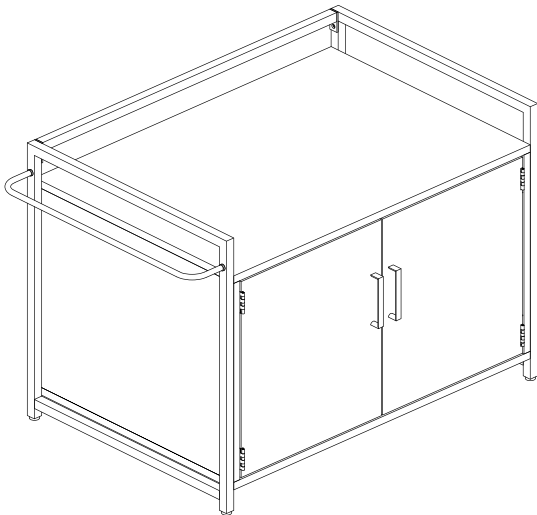
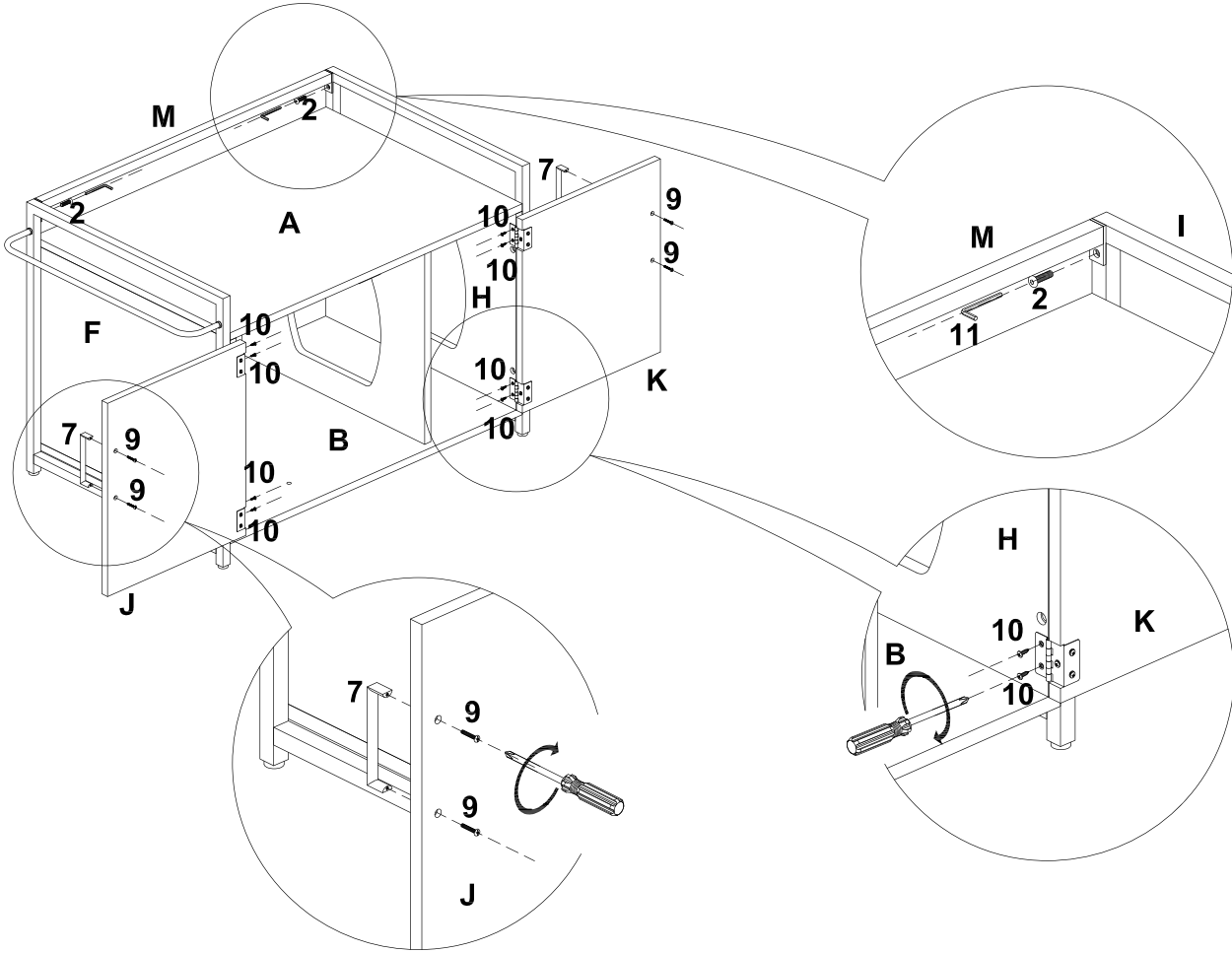

Or

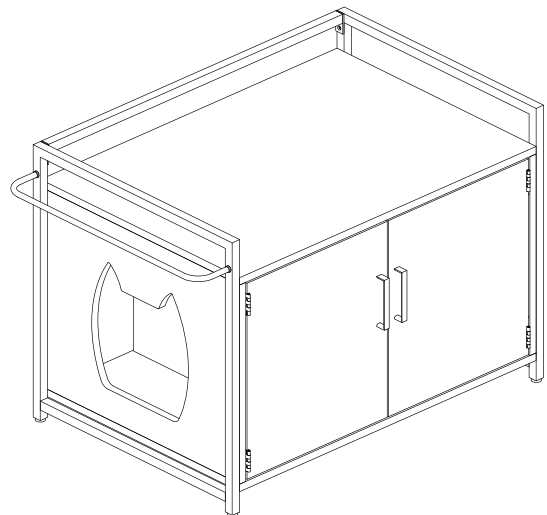

STEP 5:

1. Tighten bolt # 2 to top bar M.
2. Install the left and right door J and K to side panel F and G, tighten screw # 10 to the hinge.
3. Tighten the door handle # 7 with screw # 9.