

UNIVERSE HOME INC

ASSEMBLY AND CARE INSTRUCTION

Pet Gates with Play Pen

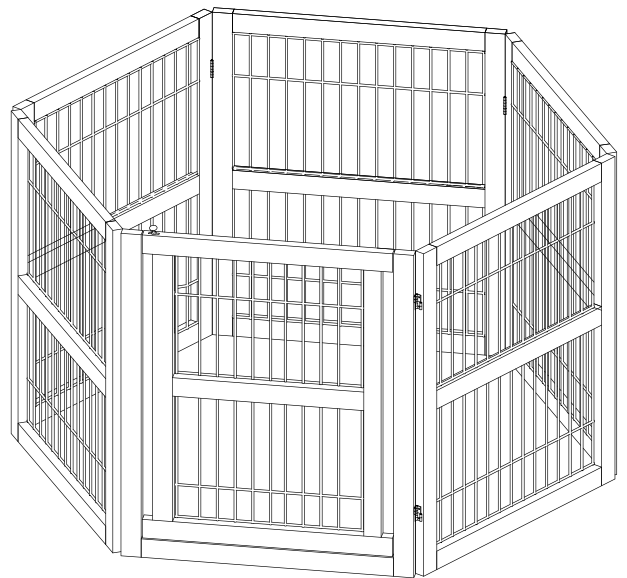

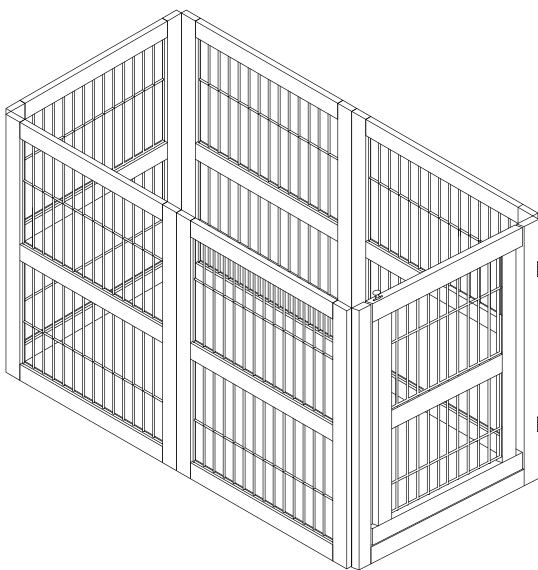
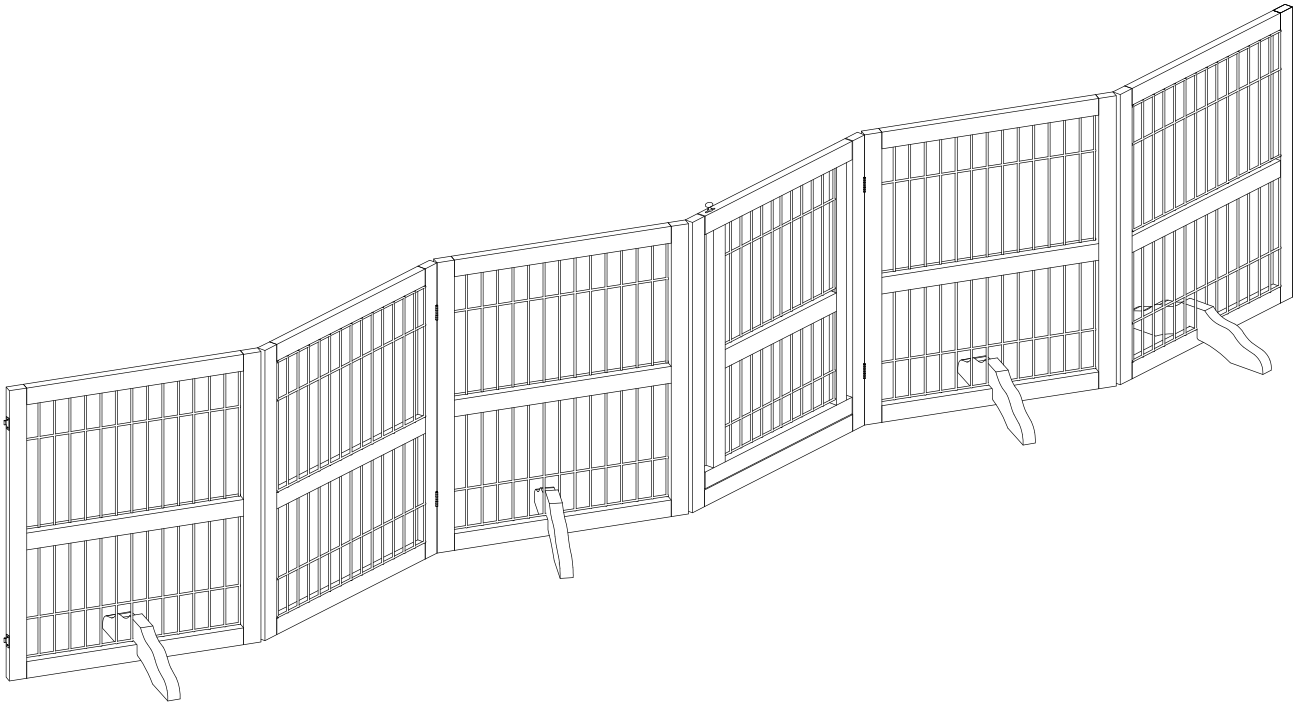
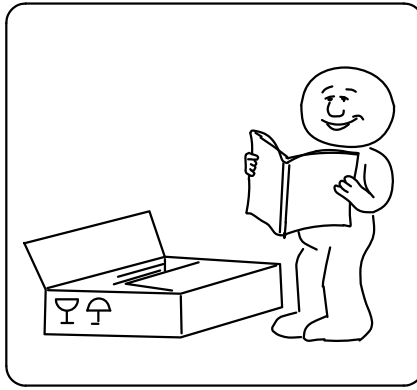
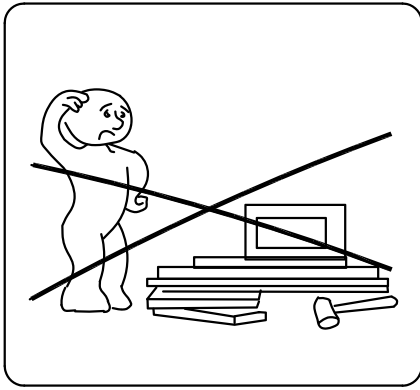

! WARNINGS !

1. PLEASE READ ALL INSTRUCTIONS CAREFULLY BEFORE STARTING ASSEMBLY.
2. DO NOT LET ANY SHARP OBJECTS TOUCH OR RUB THE SURFACE OF THE PRODUCT.
3. WHEN ASSEMBLING, DO NOT LET CHILDREN PLAY AROUND THE WORKING AREA.
4. PLEASE CONFIRM ALL PARTS ARE CORRECT BEFORE STARTING THE ASSEMBLY PROCESS.
5. DO NOT TIGHTEN ALL BOLTS AND SCREWS COMPLETELY UNTIL THE ENTIRE UNIT HAS BEEN ASSEMBLED AND SET UP.

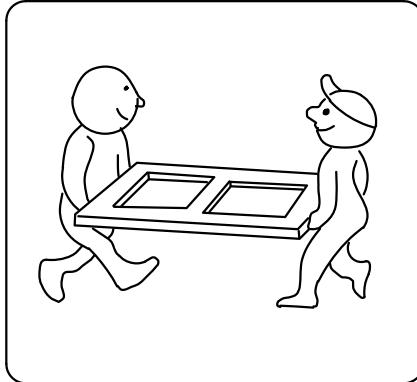
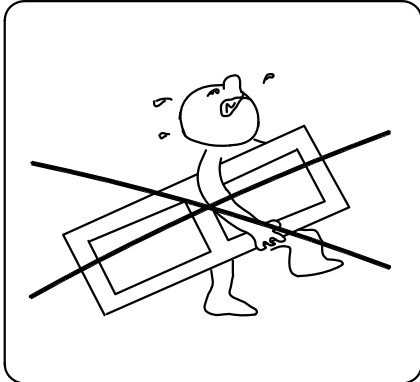
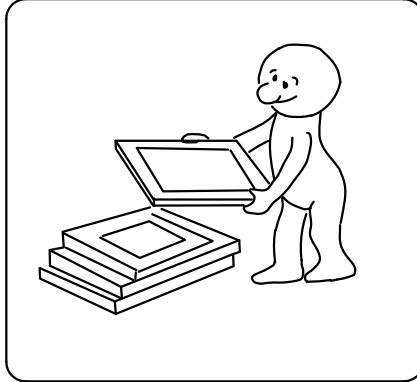
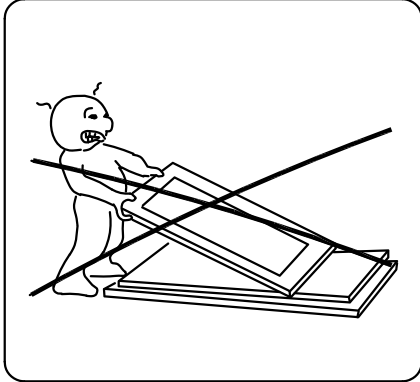

ADVISE

1. DO NOT SIT OR STAND ON THIS PRODUCT. IT IS INTENDED FOR PETS ONLY.
2. THIS PRODUCT SHOULD BE ASSEMBLED BY AN ADULT.
3. PLEASE PUT THE PRODUCT ON A SMOOTH SURFACE AFTER YOU ASSEMBLED IT.
4. PLACE ALL PARTS ON A CLEAN AND SMOOTH SURFACE SUCH AS A RUG OR CARPET TO AVOID THE PARTS FROM BEING SCRATCHED.
5. THE SCREW OF HINGE ON THE DOOR ALSO CAN BE ADJUSTABLE, TO MAKE IT EVEN THEN TIGHTEN ALL SCREWS.

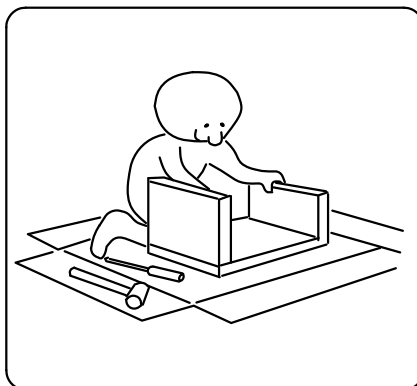
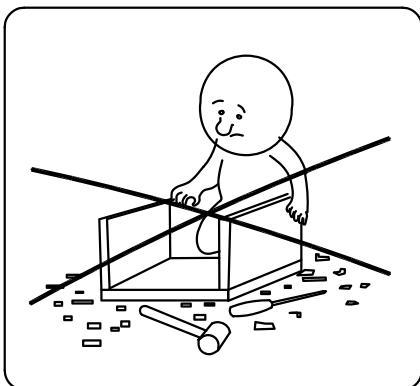
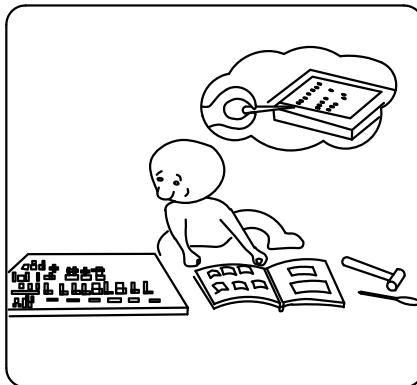
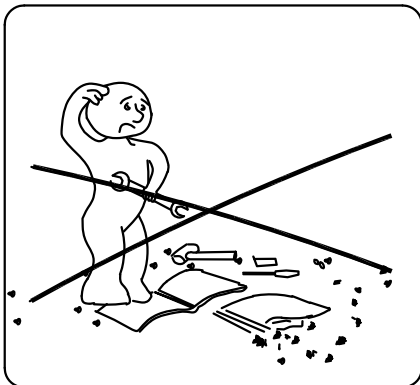

PARTS

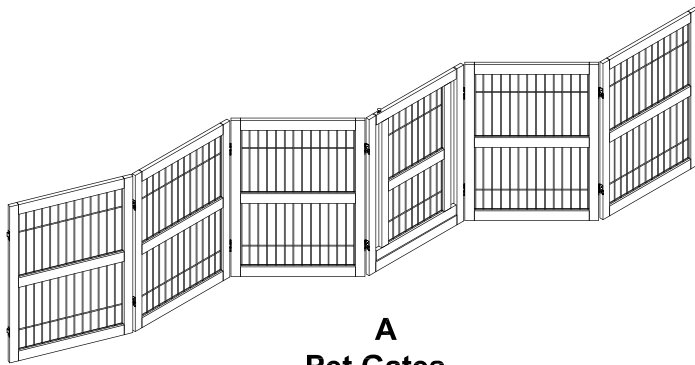
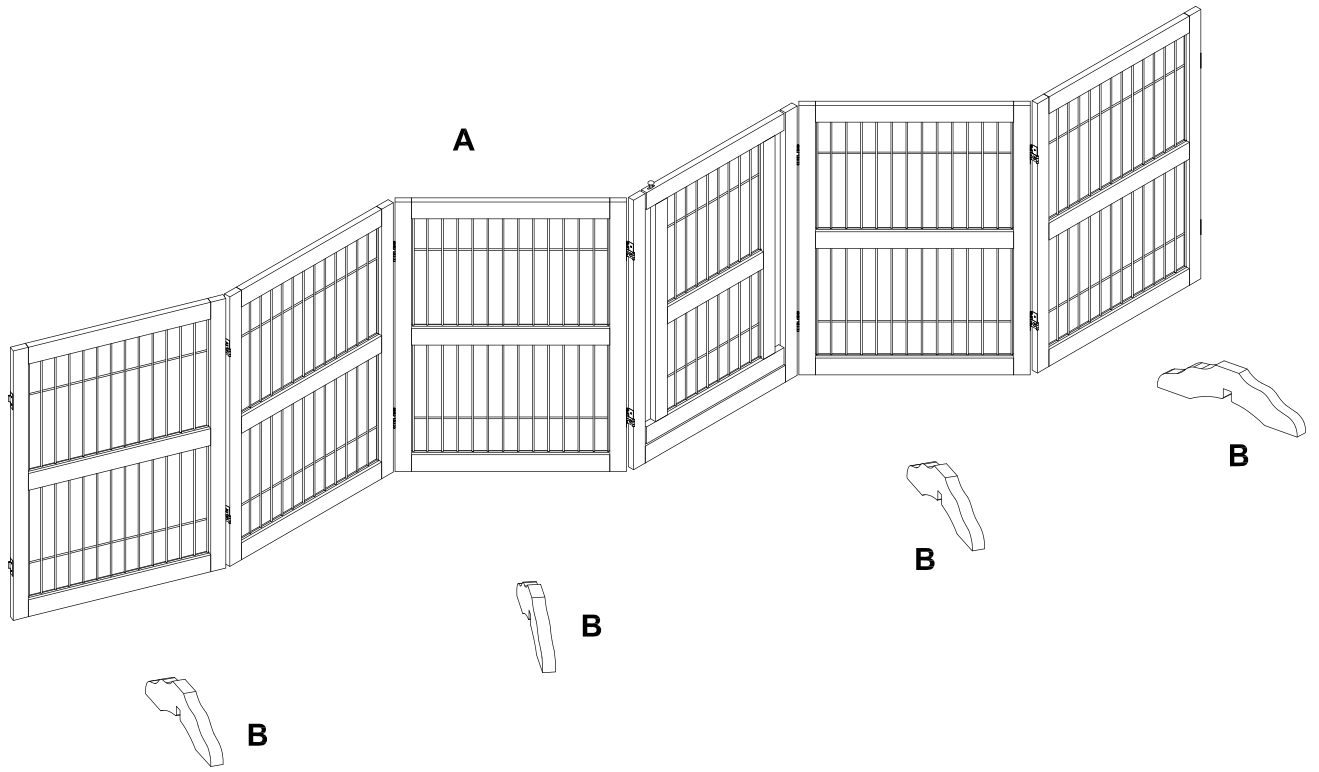

A
Pet Gates
x1



B
Support Feet
x4

HARDWARE

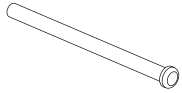

1
x 2 pcs

ASSEMBLY INSTRUCTIONS

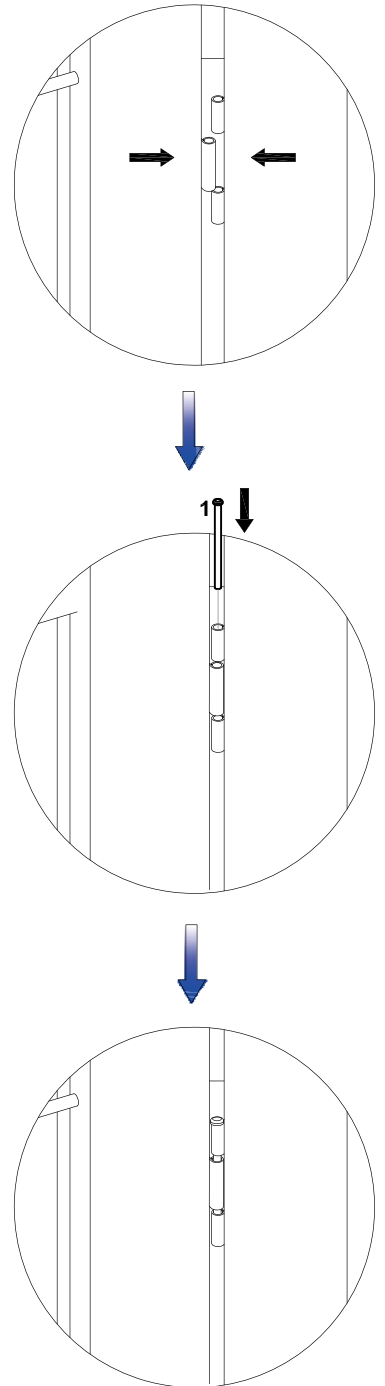
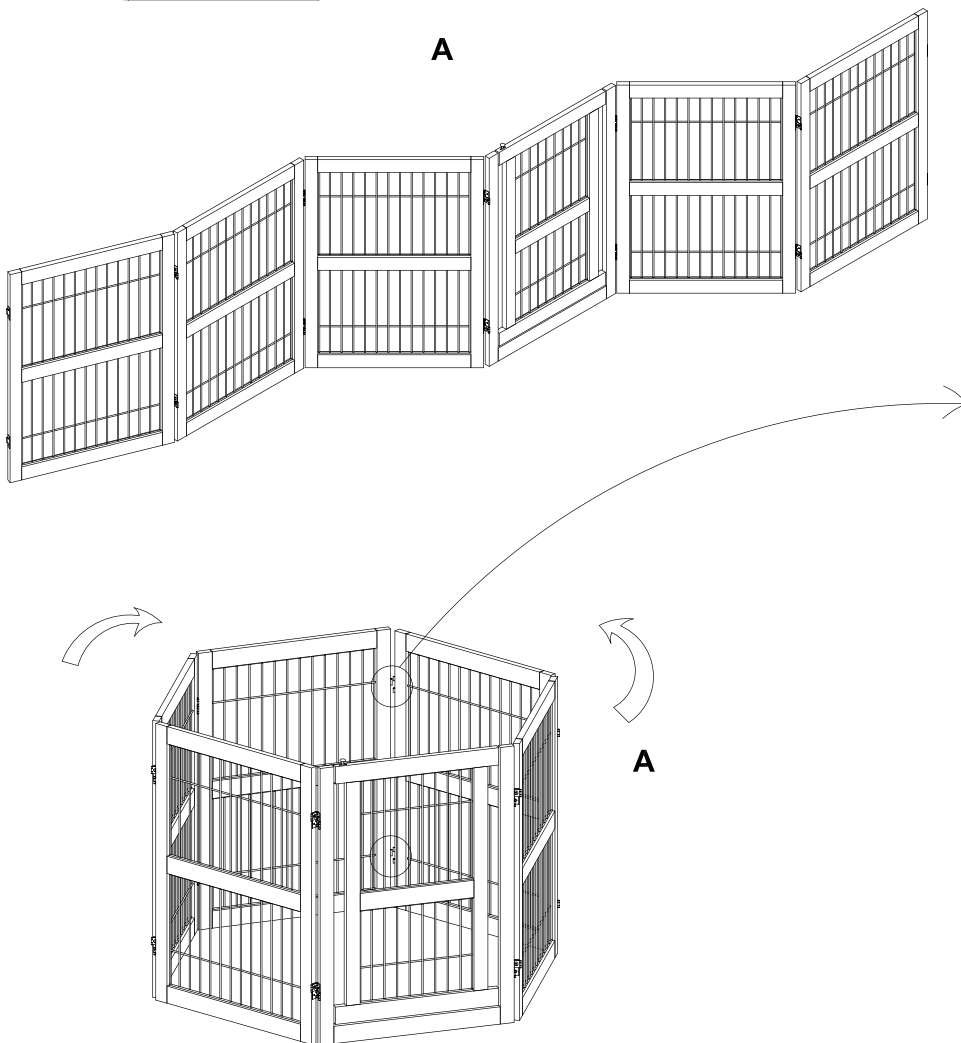
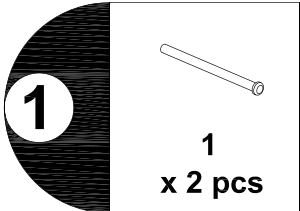

STEP 1:
Connect the gates and insert the pin #1 into the hinge to be the play pen.

OPTIONAL:

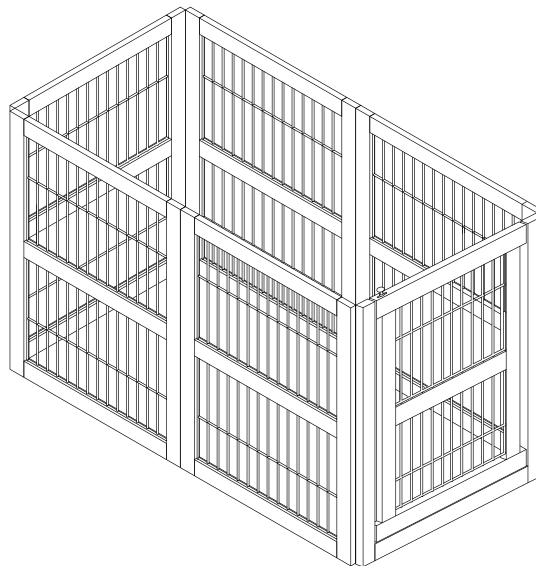
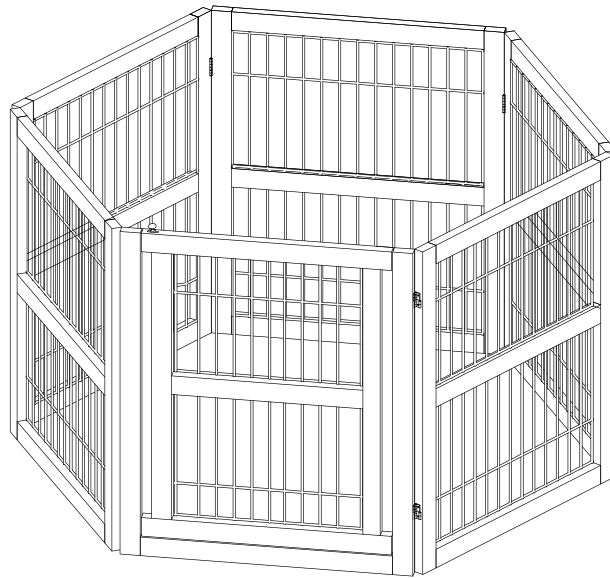

Can be different shape play pen.

OPTIONAL:

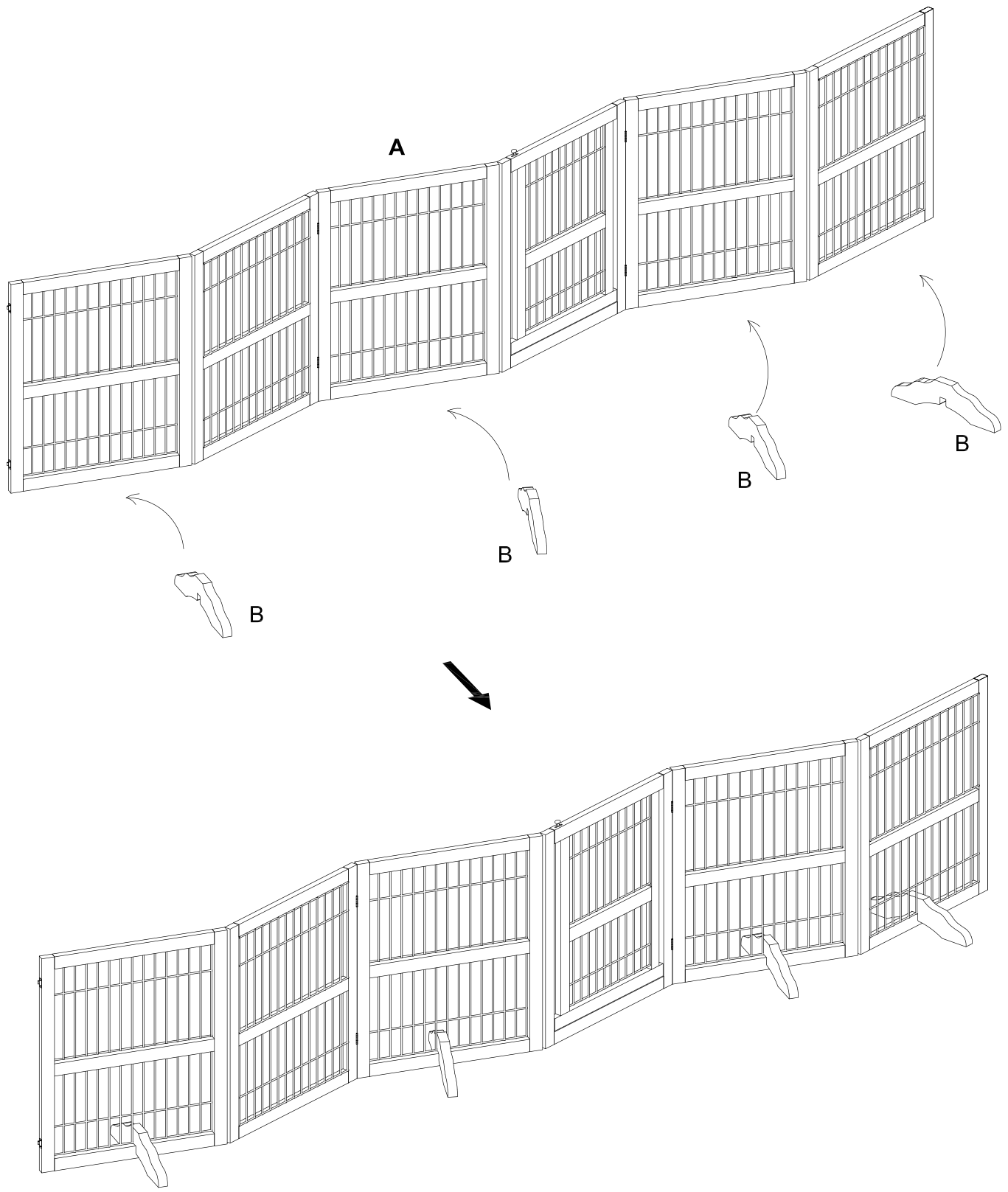

Insert the support feet B into the gates as shown above figures to be pet gates.