

NES210 series

Stick vacuum cleaner; household type

Owner's Guide

Thank you for purchasing your new Eureka vacuum!

Important instructions

For easy assembly, please take a few moments to read this owner's guide.

If you have questions about your new vacuum, please contact our customer service HELPLINE at **1-800-282-2886**. *We're here to help!*



Eureka stands by our Clean Promise seal.
Learn more at www.eureka.com/cleanpromise

www.eureka.com



eureka®

Where to find important vacuum information

Keep this information

Write the model, type and serial number here:

Date of purchase (keep your receipt) _____

Model number and type _____

Serial number _____

Find these numbers on a label on the middle back side of the vacuum cleaner. Refer to these numbers when ordering parts and accessories or if service is needed.



This Owner's Guide provides important instructions to prolong the life of your Eureka vacuum cleaner.

Registration: To register your product visit www.eureka.com and click on the 'Register Your Product' link in the top right corner.

Inspection: Carefully unpack and inspect your new Eureka vacuum cleaner for shipping damage. Each unit is tested and thoroughly inspected before shipping. For instructions regarding any shipping damage, call Eureka Customer Service **HELPLINE 1-800-282-2886** immediately.

Contents

Important safeguards	3
What comes in the carton	4
How to identify parts of your vacuum cleaner	5
How to assemble your vacuum cleaner	6
How to use your vacuum cleaner	7
How to maintain dust cup and filters	8
Problem Solving/Parts and Accesories	9
The Eureka limited warranty	10

 Follow caution information wherever you see this symbol.

IMPORTANT SAFEGUARDS

When using an electrical appliance, basic precautions should always be followed, including the following:

READ ALL INSTRUCTIONS BEFORE USING THIS VACUUM CLEANER

WARNING



To reduce the risk of fire, electric shock, or injury:

• Do not use outdoors or on wet surfaces.

• **Do not leave vacuum cleaner when plugged in.**

Turn off the switch and unplug the electrical cord when not in use and before servicing.

• Do not allow to be used as a toy. Close attention is necessary when used by or near children.

• Use only as described in this manual. Use only manufacturer's recommended attachments.

• Do not use with damaged cord or plug. If vacuum cleaner is not working as it should, has been dropped, damaged, left outdoors, or dropped into water, return it to a service center before using.

• Do not pull or carry by cord. Do not use cord as a handle. Do not close a door on cord or pull cord around sharp edges or corners. Do not run vacuum cleaner over cord. Keep cord away from heated surfaces.

• Do not use extension cords or outlets with inadequate current carrying capacity.

- Turn off all controls before unplugging.
- Do not unplug by pulling on cord. To unplug, grasp the plug, not the cord.
- Do not handle plug or vacuum cleaner with wet hands.
- Do not put any objects into openings. Do not use with any openings blocked; keep free of dust, lint, hair, and anything that may reduce airflow.
- This vacuum cleaner creates suction. Keep hair, loose clothing, fingers, and all parts of body away from openings and moving parts.
- Use extra care when cleaning stairs.
- Do not pick up anything that is burning or smoking such as cigarettes, matches, or hot ashes.
- Do not use without dust cup, filter, and pre-motor filter in place.
- Do not use to pick up flammable or combustible liquids such as gasoline, or use in areas where they may be present.
- Store your vacuum cleaner indoors in a cool, dry area.
- Keep your work area well lit.
- Unplug electrical appliances before vacuuming them.

SAVE THESE INSTRUCTIONS

To reduce the risk of electric shock, this appliance has a polarized plug (one blade is wider than the other). This plug will fit in a polarized outlet only one way. If the plug does not fit fully into the outlet, reverse the plug. If it still does not fit, contact a qualified electrician to install the proper outlet. Do not change the plug in any way.



Motor

Do Not Oil the motor at any time. The bearings are permanently lubricated and sealed.

What comes in the carton

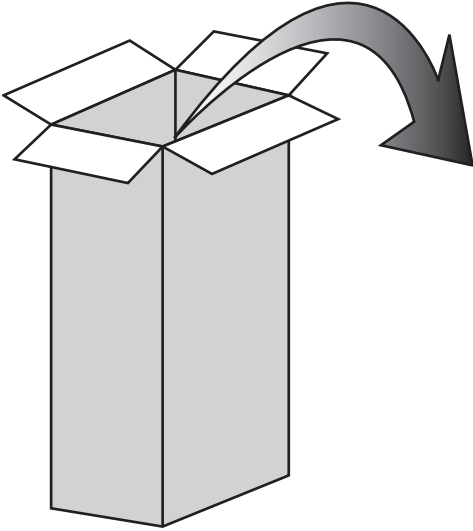

Important safeguards

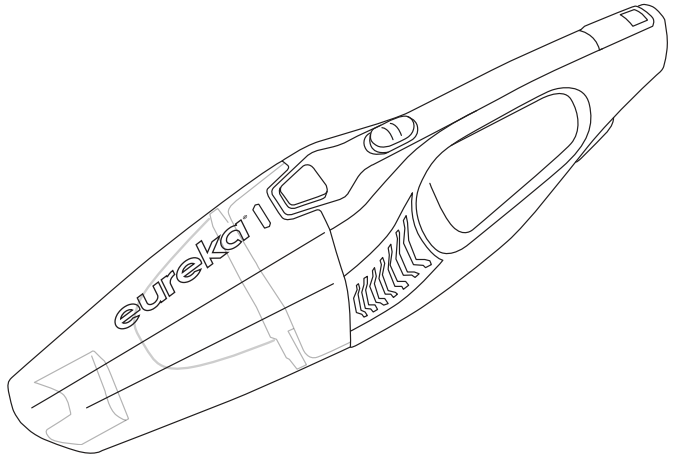

Hand vacuum

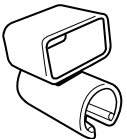

Crevice tool holder



Crevice tool

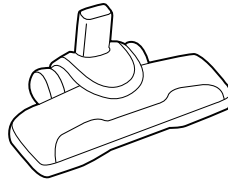

Removeable floor nozzle

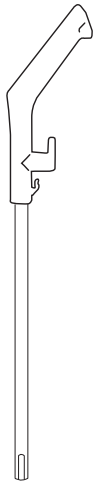

Handle

How to identify parts of your vacuum cleaner

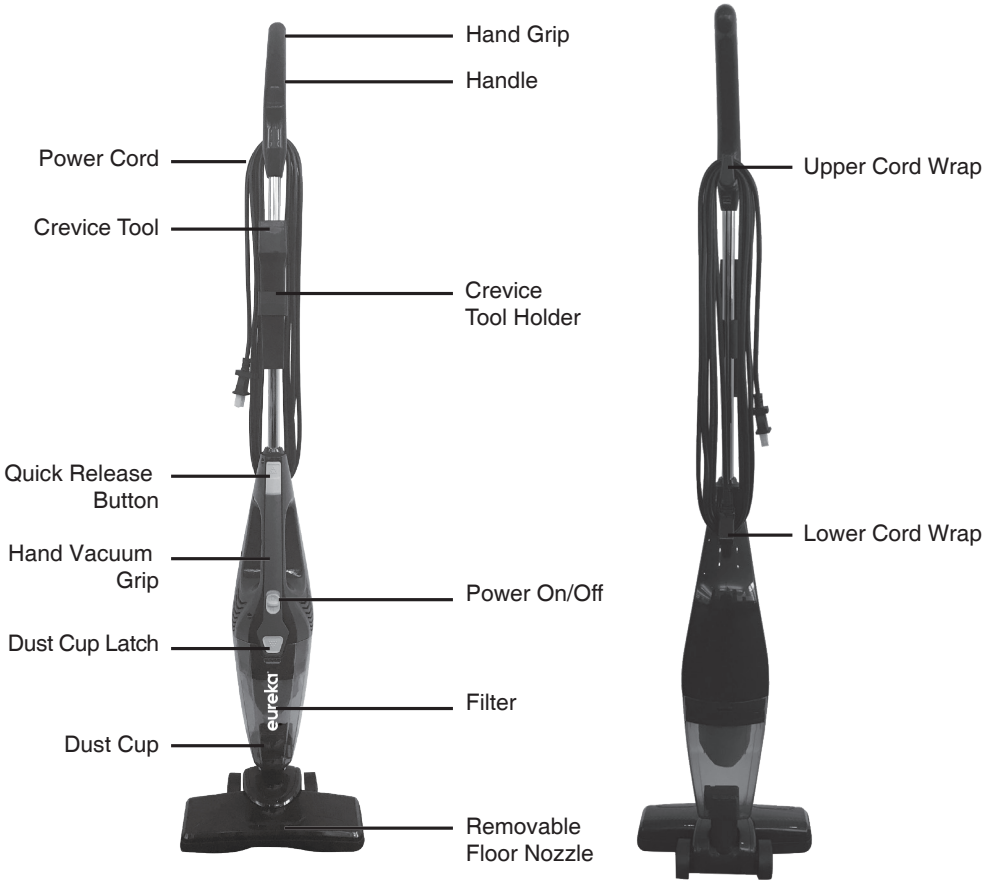

For filter maintenance instructions, see page 8

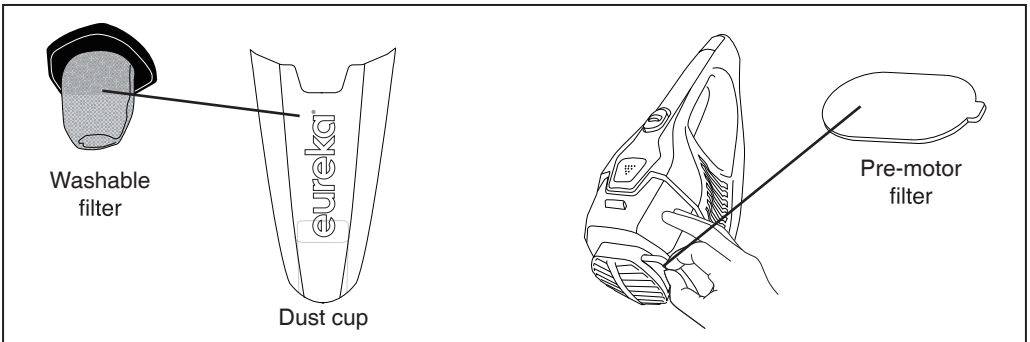

How to assemble your vacuum cleaner

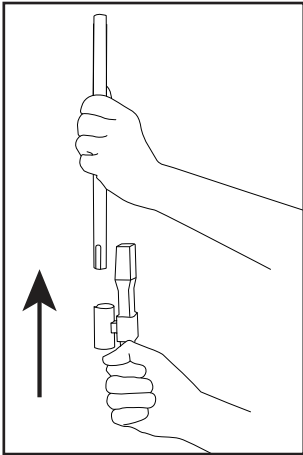

Attach crevice tool and holder by sliding it up onto the handle.

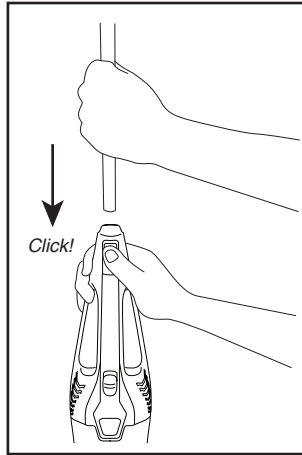

Press the quick release button on the hand vacuum grip and insert the handle. Make sure it is all the way inserted into the body of the vacuum.

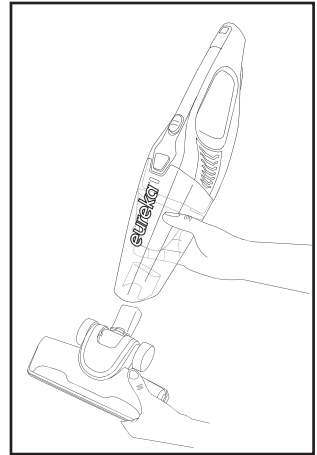

Attach the floor nozzle by inserting it into the opening at the bottom of the dust cup. Press firmly to secure in place.

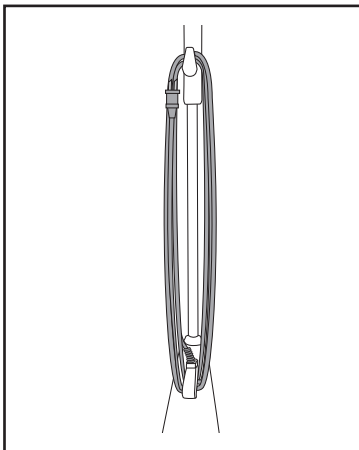

Wrap cord around the upper and lower cord wraps on the back of the vacuum. Clip plug onto the cord.

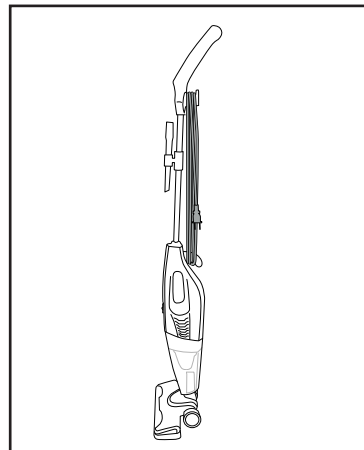

Tilt vacuum up into its upright position.

How to use your vacuum cleaner

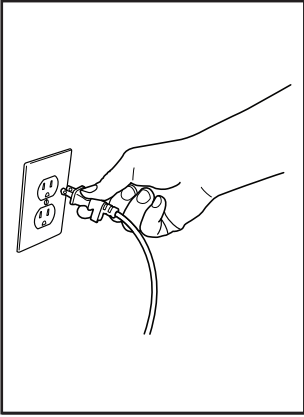

Plug power cord into the outlet.

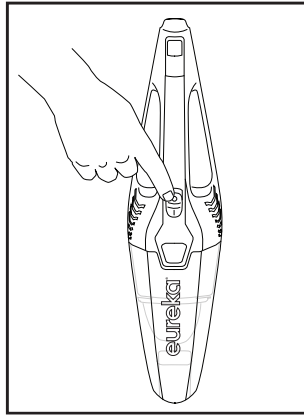

Turn on power switch on the front of the hand vacuum.

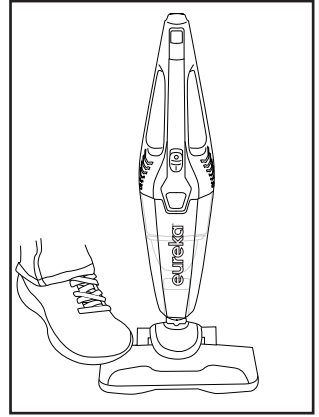

Step on nozzle and tilt vacuum to release from its upright position.

Additional usage methods

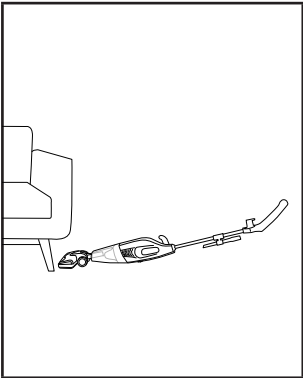

Turn hand vacuum 180° as shown for better reach under furniture.

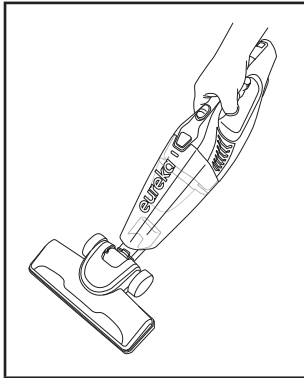

Floor nozzle may be used with the hand vacuum to clean wider surfaces.
To attach floor nozzle to the hand vacuum, insert it into the opening at the bottom of the hand vacuum. Press firmly to secure in place.

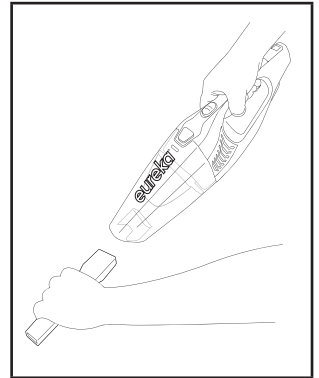

Insert crevice tool to extend the length and reach of the hand vacuum.

How to maintain dust cup and filters

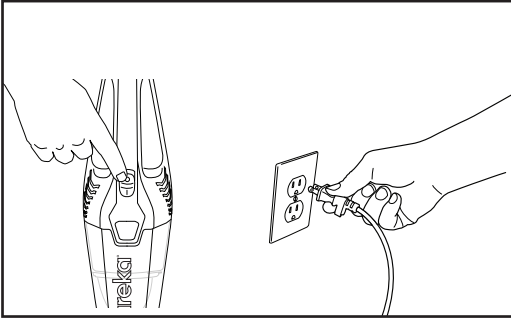

Turn vacuum off. Then, unplug the vacuum.

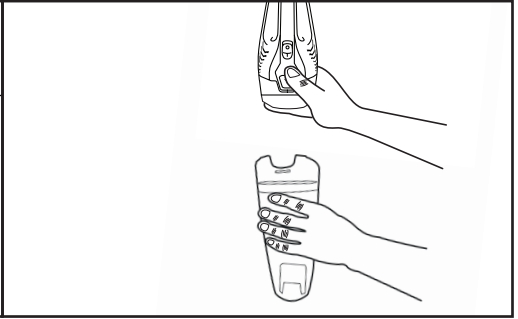

To remove dirt from the dust cup and filter, hold vacuum vertically. Press dust cup latch to release the dust cup as shown.



Gently remove the filter as shown.

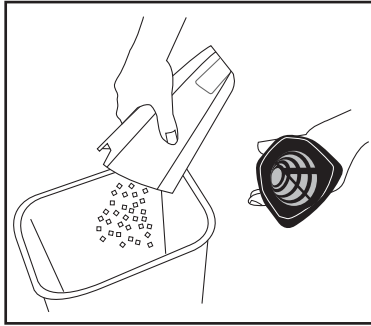

Empty dust cup into waste container.

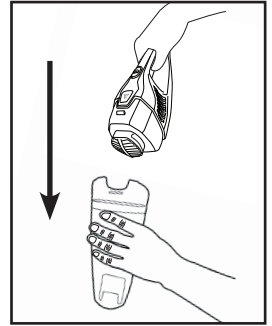

Replace filter. Attach dust cup to vacuum. Make sure dust cup is correctly secured.

Maintaining pre-motor filter

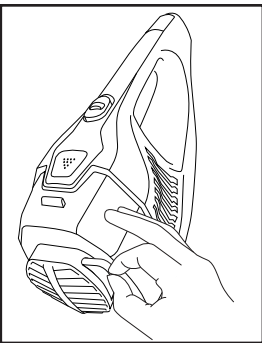

To optimize suction and cleaning performance, remove and inspect the pre-motor filter regularly.

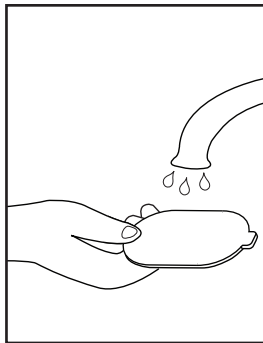

If needed, clean with warm water and a mild detergent.

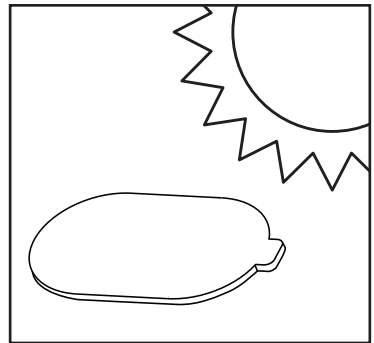





Air dry pre-motor filter for 24 hours before placing back in the vacuum.

Problem Solving

 Make sure vacuum is turned off and power cord is unplugged.

Problem	Solution
Motor will not start.	1. Push plug securely into outlet, try another outlet, or check circuit breaker.
Vacuum cleaner does not vacuum effectively.	1. Filters may be clogged, wet, or dirty. Follow instructions for cleaning filters. 2. Dust cup may be full. Follow instructions for emptying dust cup.
Dust blows out of air vents.	1. Ensure filters are properly secured.

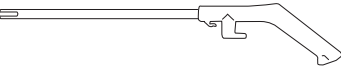
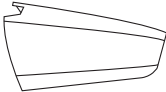
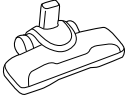
Parts and Accessories

	Filter	N0101
	Pre-motor filter	N0102
	Crevice tool	N0103
	Handle	N0104
	Dust cup	N0105
	Nozzle	N0106
	Crevice tool holder	N0107

The Eureka limited warranty

Eureka warrants this vacuum cleaner to be free from defects in material and workmanship for a term of one year for normal household use. Warranty is granted only to the original purchaser and members of immediate household.

This warranty is good for one year from the date of purchase only when the vacuum cleaner is used in the accordance with Eureka operating instructions.

Note: refurbished or remanufactured products have a one year limited warranty.

This warranty does not cover

- Parts of the vacuum that require replacement under normal use such as disposable dust bags, filters, drive belts, light bulbs, brushroll, bristles, impellers and cleaning.
- Damages or malfunctions caused by negligence, abuse, and use not in accordance with the Owner's Guide.

What Eureka will do

Eureka will, at its option, repair or replace a defective vacuum or vacuum part that is covered by this warranty. As a matter of warranty policy, Eureka will not refund the consumer's purchase price.

Obtaining warranty service

To obtain warranty service you must return the vacuum or vacuum part along with "proof of purchase" to any Eureka Authorized Warranty Station. For Eureka Authorized Warranty Station or Service Information, visit www.eureka.com, write or telephone toll free:

1-800-282-2886

Midea America Corp.

5 Sylvan Way

Parsippany, NJ 07054

Obtaining warranty service outside your community

You must pay the shipping charges to the Eureka Authorized Warranty Station.

Return shipping charges will be paid by the Warranty Station. When returning parts for repair, please include the model, type and serial number located on the rating plate on the lower backside of the vacuum.

Further limitations and exclusions

Any warranty that may be implied in connection with your purchase or use of the vacuum, including any warranty of Merchantability or any warranty for Fitness For A Particular Purpose is limited to the duration of this warranty. Some states do not allow limitations on how long an implied warranty lasts, so the above limitations may not apply to you.

Your relief for the breach of this warranty is limited to the relief expressly provided above. In no event shall the manufacturer be liable for any consequential or incidental damages you may incur in connection with your purchase or use of the vacuum.

Some states do not allow the exclusion or limitation of incidental or consequential damages, so the above limitation or exclusion may not apply to you.

This warranty gives you specific legal rights. You may also have other rights, which may vary by state.