

frisco.
better pet goods

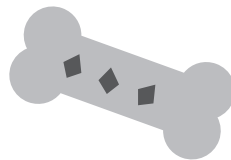
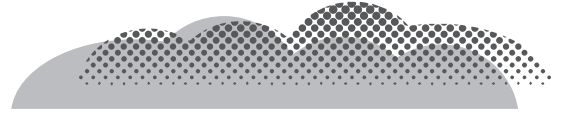
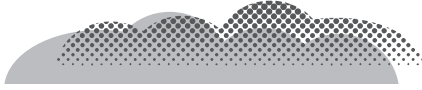

6-PANEL CONVERTIBLE PLASTIC PLAYPEN DIVIDER WITH WALL MOUNTS

INSTRUCTION MANUAL

SKU# 252045

PN# 26320

PARTS INCLUDED

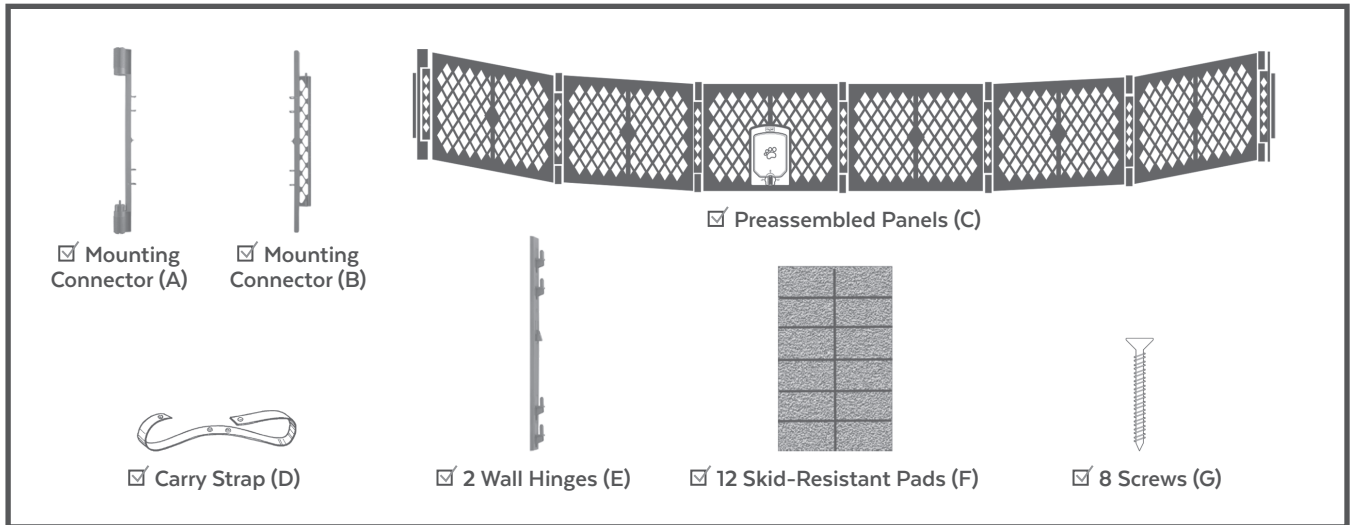

DOG PLAYPEN ASSEMBLY INSTRUCTIONS

Gloves suggested to avoid injury during assembly. Please assemble on a flat surface, and be careful not to scratch the floor.

INSTALLING SKID-RESISTANT PADS

To help protect floors, ensure the skid-resistant pads are on the bottom of the gate panels. Clean and dry the panels prior to installing the pads. Remove a single pad from the release paper as shown in Figure 1. Place the adhesive side of the pad onto the bottom edge of the gate panel approximately 2" from the center of each hinge, as shown in Figure 2. Repeat steps for each of the remaining pads. Maximum skid-resistance will be maintained by cleaning the bottoms of the pads periodically with a water-dampened clean cloth.

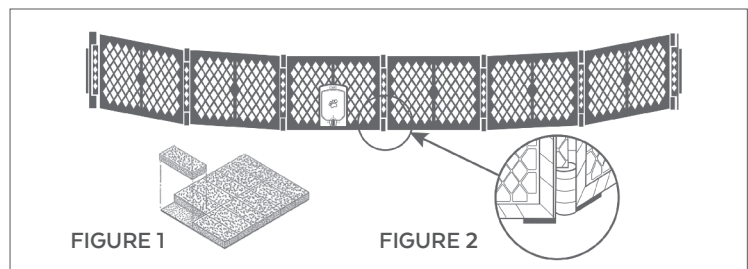

INSTALLING BETWEEN TWO WALLS

NOTE: When setting up as a barrier, maximum number of panels is six. **WARNING:** Do not mount gate hinges into sheetrock or plaster. Hardware is included for use in solid materials, such as wood or metal. Never mount the gate at the top of the stairs.

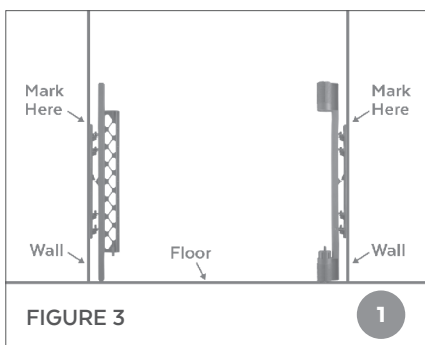

STEP 1 Position both of the preassembled wall mounting connectors/wall hinges, vertically so the wall hinge pins are facing upwards on the wall, and the mounting connector is as close to the floor as possible. Mark the top of each wall hinge. See Figure 3.

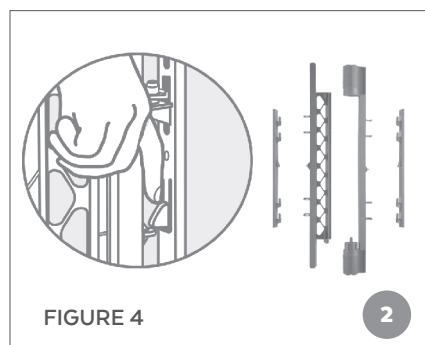

STEP 2 Separate the mounting connectors from the wall hinges by pressing inward on the locking boss located in the center of the wall hinge. Lift up on the connectors to free them from the wall hinge. See Figure 4 for removal from wall hinge.

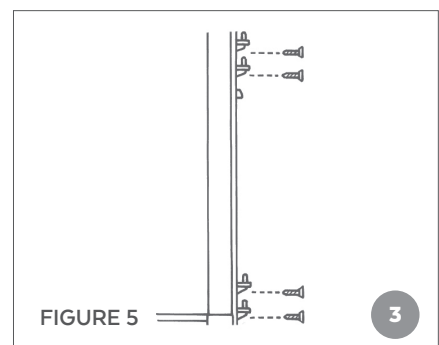

STEP 3 To attach the wall hinge to the wall, align the top with the mark drawn in Step 1. Mark the top hole and pre-drill a 1/8" pilot hole. Attach the top of the wall hinge in place with a screw. Proceed down the hinge and install a screw into each screw hole with screws provided.

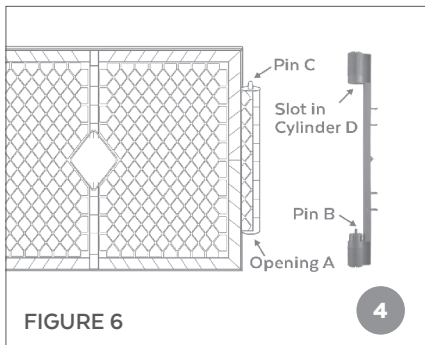

STEP 4 Attach the mounting connector side A to panel 1 by setting opening A over Pin B, push down in order to slide Pin C into the slot of Cylinder D. See Figure 6.

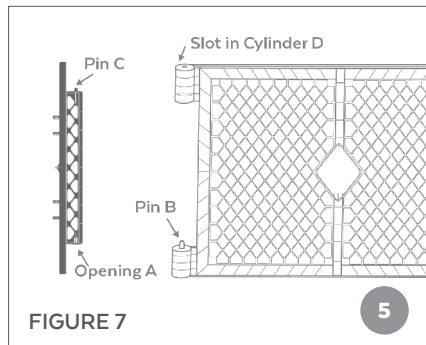

STEP 5 Attach the mounting connector side B to panel 2 by setting opening A over Pin B, push down in order to slide Pin C into the slot of Cylinder D. See Figure 7.

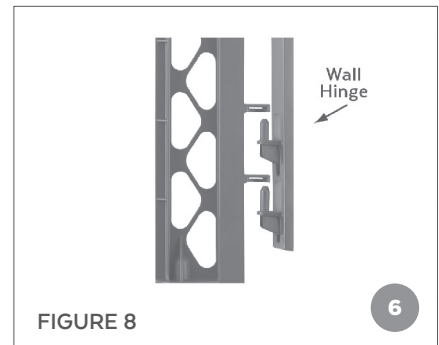

STEP 6 Attach the mounting connectors, that are now attached to the panels, to the wall hinges by aligning the horseshoe shaped hoops on one side of the gate over the pins on the wall hinges to set the gate in place. See Figure 8. **NOTE:** Always lift up on the end panels to ensure that the gate is properly secured and locked in place.

REMOVAL FROM WALL HINGE

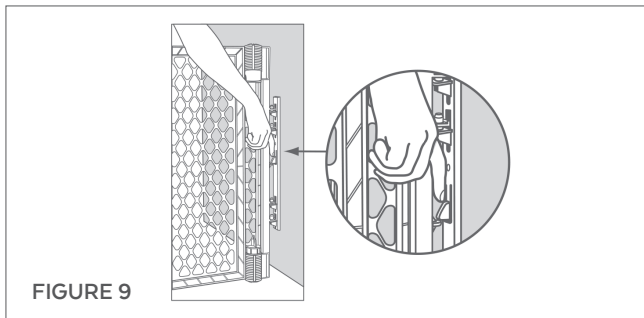

To remove the gate from the wall hinge, press on the locking boss located on the center of the wall hinge (See Figure 9), and lift the panel itself until the gate rib clears the locking boss.

TO DISCONNECT PANELS

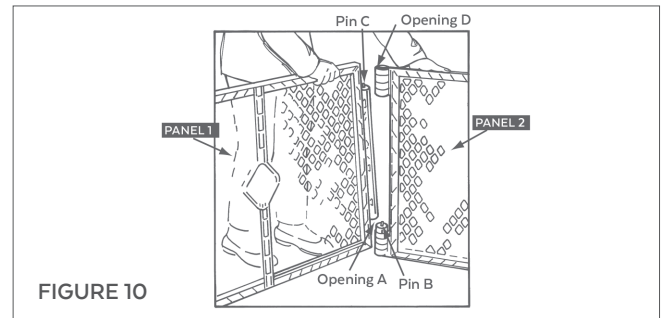

To disconnect two adjoining panels, select one of the joints where the panel pushes down (panel 1), as shown in Figure 10. Gently press down on panel 1 while lifting slightly on panel 2. This will enable you to slide Pin C free of Cylinder D (see Figure 10). Then lift up on panel 1 until Opening A (see Figure 10) is free of Pin B.

INSTALLATION AS A FREESTANDING ENCLOSURE

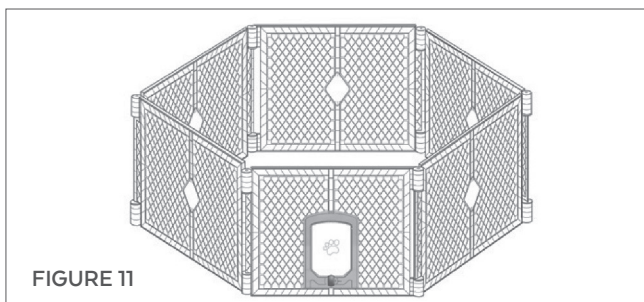

Begin setting up your enclosure by unsnapping the gray carrying strap and carefully unfolding the panels to form a hexagon. See Figure 11. When you have finished unfolding the panels, there will be two unconnected panels arranged as shown in Figure 12. Make certain that the pin in Cylinder B is up as shown. Begin connecting the panels together by gently lifting up on panel 2 and setting the Opening A (as shown in Figure 12) over Pin B located on panel 1.

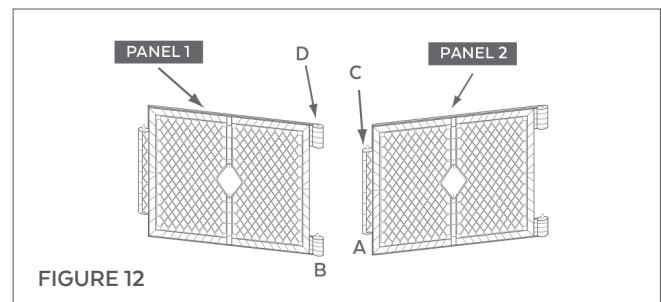

Now locate the slot on the lower end of Cylinder D. See Figure 12. This slot tapers to an opening that accommodates Pin C. Gently press down on panel 2 while aligning Pin C with the slot in Cylinder D. While maintaining downward pressure on panel 2, lift slightly on panel 1, and slide Pin C through the slot and into the opening as shown.



PET DOOR OPERATION

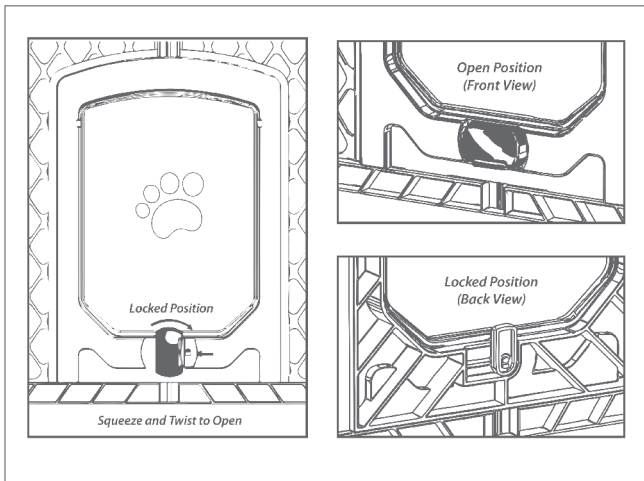

Your gate comes from the factory with the pet door in the locked position.

TO UNLOCK Squeeze and twist the front center knob located below the pet door. As you twist, the knob will line up with the arrows on the right or left sides of the knob. The pet door will move freely in both directions for your pet to pass through.

TO LOCK Squeeze and twist the front center knob located below the pet door. As you twist, the knob will be in the upright position, keeping the door securely locked.

FOLDING FOR TRANSPORT OR STORAGE

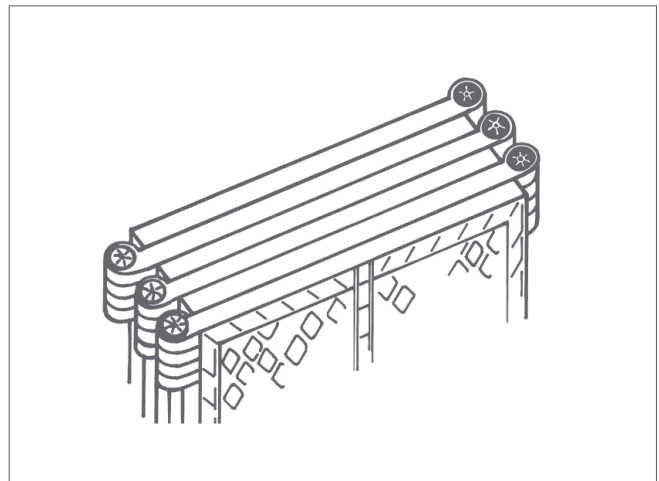

Your gate folds compactly for transport or storage. You must, however, fold the panels properly. Gently fold the panels (without jerking them or slamming them together) in alternating directions like an accordion.

Slip one end of the gray carrying strap through the mesh near the top middle of each outside panel and snap it closed. The gate is now ready for transport or storage.



CLEANING TIPS

Your gate is manufactured from durable, weather-resistant plastic panels. To clean, wash the panels with mild, non-abrasive detergent, rinse with clean water, and allow to dry thoroughly.

WARNINGS AND CAUTIONS

We care about the safety of your pet, so please **READ AND FOLLOW ALL INSTRUCTIONS** before using. Improper use may result in serious injury or even the death of your pet.

- STOP using when a pet can climb over yard or dislodge/open the gate.
- Install only with the locking/latching mechanism securely engaged.
- To prevent falls, NEVER use at top of stairs.
- This product will not necessarily prevent all accidents.
- Periodically check all fasteners to be sure they are tight and secure, stop using if any parts are missing or become damaged.
- Wall mount hardware is included for use in solid materials only, such as wood or metal.
- NEVER leave anything in the pet yard that could provide a foothold or create a danger of suffocation or strangulation.
- Do not use this product on a smooth slippery surface unless skid-resistant pads are used (included).
- Do not attempt to use this product in temperatures less than 40 degrees F, or damage may result.
- Do not use as a barrier for stairways, stoves or heaters.
- Do not use on uneven surfaces.
- When setting up as an enclosure, do not connect more than 8 panels. When setting up as a barrier, maximum number of panels is six.

QUESTIONS?

CALL OUR FRIENDLY CUSTOMER SERVICE TEAM ANYTIME.
WE'RE HERE 24/7! 1-800-67-CHEWY (672-4399)