



## ScatMat® Indoor Training Mat

ZPD00-17030

Curved – 50 in. L x 12 in. W

PPD00-17077/ZPD00-17031

Large – 48 in. L x 20 in. W

ZPD00-17032

Large Extension – 48 in. L x 20 in. W

ZPD00-17033

Medium – 30 in. L x 16 in. W

ZPD00-17034

Strip – 46 in. L x 3 in. W

PPD00-17035/ZPD00-17036

Sofa – 60 in. L x 12 in. W

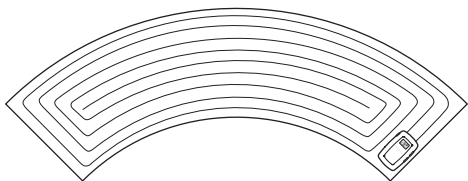

Curved – 50 in. x 12 in.

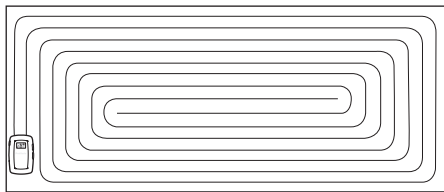

Large – 48 in. x 20 in.

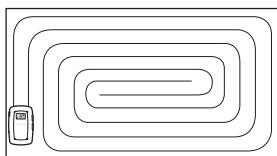

Medium – 30 in. x 16 in.

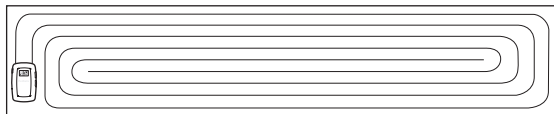

Sofa – 60 in. x 12 in.

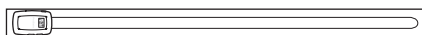

Strip – 46 in. x 3 in.

Please read this entire product manual before beginning.

## Welcome

You and your pet were made for each other. Our aim is to help you have the best companionship and the most memorable moments together. Your ScatMat® training mat is designed to keep pets away from off-limits areas.

We know that safe pets make happy owners. Before getting started, please take a moment to read through the important safety information. If you have any questions, please don't hesitate to contact us.

---

Hereinafter Radio Systems Corporation, Radio Systems PetSafe Europe Ltd., Radio Systems Australia PTY Ltd. and any other affiliate or brand of Radio Systems Corporation may be referred to collectively as "We" or "Us."

# IMPORTANT SAFETY INSTRUCTIONS

Explanation of Attention Words and Symbols used in this Product Manual



This is the safety alert symbol. It is used to alert you to potential personal injury hazards. Obey all safety messages that follow this symbol to avoid possible injury or death.

## **⚠ WARNING**

WARNING indicates a hazardous situation which, if not avoided, could result in death or serious injury.

## **⚠ CAUTION**

CAUTION, used with the safety alert symbol, indicates a hazardous situation which, if not avoided, could result in minor or moderate injury.

## **CAUTION**

CAUTION, used without the safety alert symbol, indicates a hazardous situation which, if not avoided, could result in harm to your pet.

## **NOTICE**

NOTICE is used to address practices not related to personal injury.

---

## **⚠ WARNING**

- Do not use this product if your pet is aggressive or is prone to aggressive behavior. Aggressive pets can cause severe injury and even death to their owner and others. If you are unsure whether this product is appropriate for your pet, please consult your veterinarian or a certified trainer.

## **⚠ CAUTION**

- Do not use this product on or near a stairway.
- Mats can present a tripping or slipping hazard.
- Do not use this product near fire or open flame.
- Avoid touching the corrective portion of this product while it is turned on.
- Keep away from children.
- Warn others of the presence of this product.
- This product is not a toy. Use it only to deter pets from particular areas.

## CAUTION

- Be sure to never force or entice your pet onto the ScatMat® training mat.

## NOTICE

- For indoor use only. Do not submerge this product in water.
- Do not use a rechargeable battery.
- Do not place near electrical appliances or extension cords.

# SAVE THESE INSTRUCTIONS

---

## What's Covered

In the Box.....	4
Features.....	4
How It Works.....	5
Controller LCD Display.....	5
Start Here.....	6
Turning the ScatMat® Training Mat On and Off.....	7
Setting and Testing the Static Correction.....	7
Training Guide.....	7
Tips and Maintenance.....	8
Resetting the Activity Counter.....	9
Frequently Asked Questions.....	9
Troubleshooting.....	9
Customer Care International.....	10
Terms of Use and Limitation of Liability.....	10
Compliance.....	11
Important Recycling Advice.....	11
Warranty.....	11

## In the Box

The system requires one 9V alkaline battery (not included).

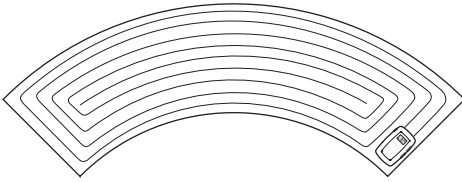

Curved – 50 in. x 12 in.

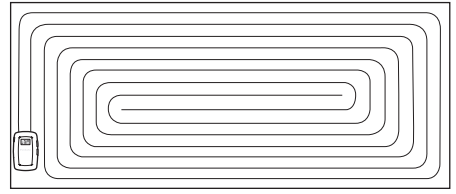

Large – 48 in. x 20 in.

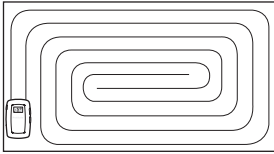

Medium – 30 in. x 16 in.

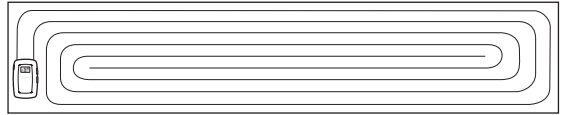

Sofa – 60 in. x 12 in.

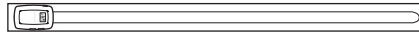

Strip – 46 in. x 3 in.

## Features

- 7 settings for dogs or cats of any size
  - Tone only
  - Low static correction with and without tone
  - Medium static correction with and without tone
  - High static correction with and without tone
- Battery-operated system can be used anywhere indoors
- Flexible mat rolls up for convenient storage
- Removable controller for easy cleaning
- Activity counter shows when pets are no longer testing the ScatMat® training mat
- Battery status indicator
- Low battery alarm

## Prevent Your Pet From:





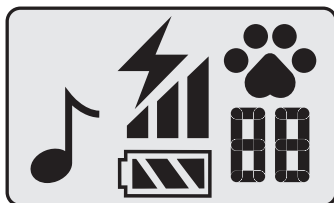
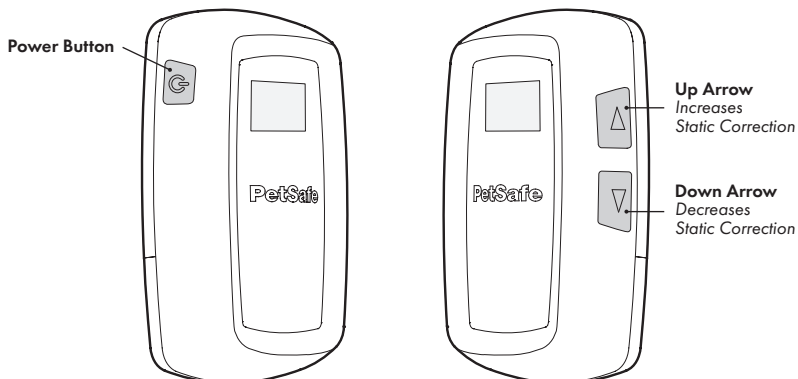

- Jumping on furniture
- Counter surfing
- Jumping on automobiles
- Entering a room

## How It Works

The PetSafe® ScatMat® training mat provides a correction when your pet steps onto the surface. Small wires embedded inside the mat detect his step and sends a static correction. The correction is harmless, yet startling. Pets quickly learn to avoid the area where the ScatMat® training mat is located. Train your pet to avoid furniture, counters and other off-limits area quickly and safely.



### Controller LCD Display

	<b>Warning Tone</b>	Sound is on. Displays for tone-only warning and tone-with-static correction.
	<b>Static Correction</b>	Displays when static correction is on.
	<b>Static Correction Level</b>	Displays the level of static correction. Represents 3 levels of static correction: Low (1 bar), Medium (2 bars), High (3 bars)
	<b>Activity Indicator</b>	The paw icon lights when a pet is detected on the mat.
	<b>Activity Counter</b>	Displays the total number of pet interactions with the mat.
	<b>Battery Power</b>	Displays when using battery power and shows the battery status.
	<b>Calibration</b>	Displays for 4 seconds when the mat is calibrating.

## Start Here

1. Remove the battery cover by pressing down on the arrow on the back of the controller and sliding it in the direction of the arrow.
2. Install a new 9V alkaline battery (not included) designed to fit one way.
3. Replace the battery cover.

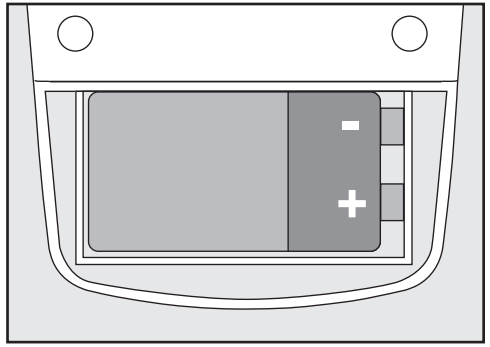

4. Unroll the mat and lay it flat.
5. Slide the two bottom hooks on the back of the controller through the openings in the corner of the mat.

**Note:** Be careful not to touch the side buttons while attaching the controller to the mat as you may accidentally power on the controller.

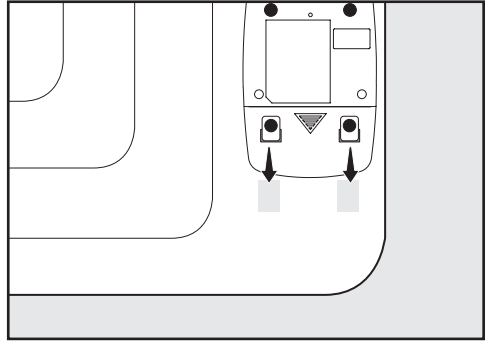

6. There are two snaps on the mat and two snaps on the back of the controller. Firmly snap the two together.

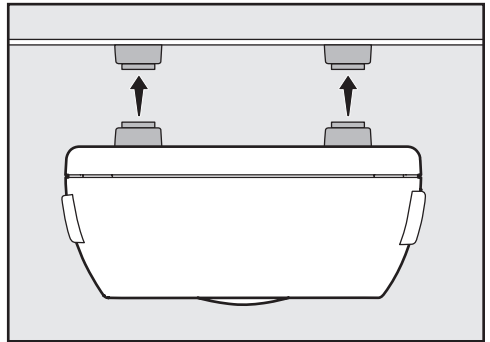

## Calibration

7. Place the mat in the desired location. Power on the controller and move away from the mat. It will now calibrate automatically, displaying 2 dashed lines for 4 seconds. Repeat these steps each time the mat is moved to a new location.

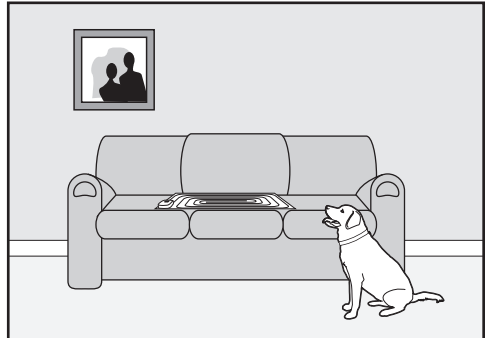

## Turning the ScatMat® Training Mat On and Off

- To power on the controller, press and release the power button. Two dashes will appear on the LCD display for 4 seconds while the controller is calibrating.
- To power off the controller, press and hold the power button for 3 seconds.

## Setting and Testing the Static Correction

- After powering on the controller for the first time, the initial setting is tone-only with no static correction. The tone icon will be displayed on the LCD display.
- To test the operation of the ScatMat® training mat before adding static correction, touch 2 wires of the mat with the side of your hand. The controller should sound multiple tones as you touch the mat, and the activity counter should display a number each time.
- To add static correction along with tone, press the up arrow button. The static correction icon will appear. With each up arrow button press, the static correction bars on the LCD display will increase from 1 bar (low) to 2 bars (medium) to 3 bars (high).
- To remove the tone, press the up arrow button again. The tone icon will disappear as the bars start over again at 1 bar (low) and go to 2 bars (medium) and then 3 bars (high).
- To lower the level of static correction, press the down arrow button. With each down arrow button press, the bars will decrease from 3 bars (high) to 2 bars (medium) to 1 bar (low).
- Use the up and down arrow buttons to cycle through the settings as needed.
- The controller holds the last setting when powering it off and on again.

**⚠ CAUTION** Avoid touching the corrective portion of this product while it is turned on.

## Training Guide

Your pet will learn to avoid the ScatMat® training mat after receiving a tone-only warning or tone-with-static correction. In some cases, it may not be necessary to train your pet. You can let your pet wander freely to determine the new boundaries. Monitor your pet during his first session. Pets learn at different rates and it may take several times for your pet to successfully understand and honor the ScatMat® training mat. Continue to use the ScatMat® training mat even if you are not successful on day one. It may take 2–4 days for our pet to learn to avoid the mat. Use the activity counter to monitor progress. If you see an increase in activity, it may be time to increase the correction level.

### Static Correction Levels

You may start on tone-only or adjust the static correction level appropriate for your pet's temperament.

### Begin Your Pet's First Session

1. Move your pet away from the ScatMat® training mat.
2. Choose the tone-only or tone-with-static correction level.
3. Allow your pet to wander freely around the mat.

If your pet is confused or unsure how to avoid the ScatMat® training mat then you may need to teach your pet how to do so by following these steps:

1. Place a collar on your pet and attach a long leash. For cats, we recommend using a harness.
2. Walk your pet onto the ScatMat® training mat. As soon as you hear the tone, gently pull him away from the mat and back into the safe zone.
3. Reward your pet with praise each time he leaves the ScatMat® training mat.
4. Practice this technique a few times until you feel that your pet is mastering avoidance of the mat.

**CAUTION** Be sure to never force or entice your pet onto the ScatMat® training mat.

## Tips and Maintenance

### Positioning the ScatMat® Training Mat

Place your ScatMat® training mat where your pet is exhibiting undesirable behavior such as on tables or counters. Alternatively, you can use the ScatMat® training mat to block your pet's access to an area either in a doorway or on the floor in front of an object.

### Automobile Use

To prevent any damage to the surface of the automobile, we recommend placing a soft cloth between the automobile and the ScatMat® training mat. For indoor use only.

### Water-resistant

The mat is water resistant, not waterproof. Do not submerge the mat or the controller in water.

### Climate

If you are using the indoor ScatMat® training mat in a cold climate less than 60°F, the mat may become creased. Move it to an area above 60°F to remove creasing.

### Care and Maintenance

- Remove the controller from the mat by unsnapping. Clean the mat as needed with a cloth and mild soapy water. Dry the mat with a towel. Do not submerge the mat or controller in water. After the mat has dried, re-attach the controller.
- Do not allow the metal buttons on the back of the controller to lie on a metallic surface.
- Do not place metallic objects on the ScatMat® training mat.
- If your ScatMat® training mat has creases, you can remove the creases by applying heat with a hairdryer on a low setting.
- When not in use, roll up your ScatMat® training mat.

### Battery Life

- The average battery life is 6 months.
- To conserve battery life, turn the controller off while the ScatMat® training mat is not in use.
- A low battery alarm sounds 3 short beeps every 60 seconds when 0 bars are displayed on the battery icon.

### Time Out Feature

As a built-in safety feature, if your pet remains on the ScatMat® training mat for more than 15 seconds, the static correction will time out and automatically shut off for 10 seconds. If your pet remains on the mat, the correction pattern will resume.



## Resetting the Activity Counter

The activity counter displays up to 99 interactions with the mat. To reset it back to 0, momentarily press the power button while the controller is powered on. The activity counter will remain on 99 until you reset it.

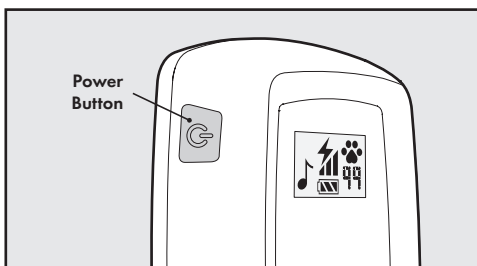

## FREQUENTLY ASKED QUESTIONS

<b>Will the ScatMat® training mat work for my dogs or cats?</b>	The ScatMat® training mat is safe and effective for all breeds and sizes of dogs and cats.
<b>Is the static correction safe for my pet?</b>	While the static correction is unpleasant, it is harmless to your pet. For more information about static correction, visit <a href="http://petsafe.com">petsafe.com</a> .

## Troubleshooting

The answers to these questions should help you solve any problems you have with your ScatMat® training mat. If they do not, please contact our Customer Care Center or visit our website at [www.petsafe.com](http://www.petsafe.com).

## TROUBLESHOOTING

<b>My pet does not respond to the ScatMat® training mat.</b>	<ul style="list-style-type: none"><li>• Make sure the ScatMat® training mat contains a 9V alkaline battery (not included) and is turned on.</li><li>• Replace the battery and test again.</li><li>• Test the ScatMat® training mat by ensuring you are touching two wires on the mat.</li><li>• Increase the static correction setting.</li><li>• Leave the mat in place a little longer as even well insulated paws will step on two wires and feel the pulses.</li></ul>
<b>The ScatMat® training mat will not turn on.</b>	<ul style="list-style-type: none"><li>• Check to be sure that the battery has been installed properly.</li><li>• Press the power button until the display comes on.</li><li>• If the mat is still not on, contact the Customer Care Center.</li></ul>

# Customer Care International

USA & Canada - Tel: +1 (800) 732-2677 – Monday - Friday 8 AM - 8 PM, Saturday 9 AM - 5 PM

Australia - Tel: 1800 786 608 – Monday - Friday 8:30 AM - 5 PM

New Zealand - Tel: 0800 543 054 – Monday - Friday 10:30 AM - 7 PM

---

## Terms of Use and Limitation of Liability

### 1. **Terms of Use**

The use of this product is subject to your acceptance without modification of the terms, conditions and notices contained with this product. Use of this product implies acceptance of all such terms, conditions, and notices. If you do not wish to accept these terms, conditions, and notices, please return the product, unused, in its original packaging and at your own cost and risk to the relevant Customer Care location together with proof of purchase for a full refund.

### 2. **Proper Use**

Proper Use includes, without limitation, reviewing the entire Product Manual and any specific safety information statements. The specific temperament or size/weight of your pet may not be suitable for this product. If you are unsure whether this product is appropriate for your pet, please consult your veterinarian or certified trainer prior to use. For products used with pets where training is desired, Radio Systems Corporation recommends that these training products are not used if your pet is aggressive and accepts no liability for determining suitability in individual cases.

### 3. **No Unlawful or Prohibited Use**

This product is designed for use with pets only. This product is not intended to harm, injure or provoke. Using this product in a way that is not intended could result in violation of Federal, State or local laws.

### 4. **Limitation of Liability**

In no event shall Radio Systems Corporation or any of its associated companies be liable for (i) any direct, indirect, punitive, incidental, special or consequential damage and/or (ii) any loss or damages whatsoever arising out of or connected with the use or misuse of this product. The Purchaser assumes all risks and liability from the use of this product to the fullest extent permissible by law.

### 5. **Modification of Terms and Conditions**

Radio Systems Corporation reserves the right to change the terms, conditions and notices governing this product from time to time. If such changes have been notified to you prior to your use of this product, they shall be binding on you as if incorporated herein.

## Compliance

### FCC: USA

This device complies with part 15 of the FCC Rules. Operation is subject to the following two conditions: (1) This device may not cause harmful interference, and (2) this device must accept any interference received, including interference that may cause undesired operation.

Note: This equipment has been tested and found to comply with the limits for a Class B digital device, pursuant to part 15 of the FCC Rules. These limits are designed to provide reasonable protection against harmful interference in a residential installation. This equipment generates, uses, and can radiate radio frequency energy and, if not installed and used in accordance with the instructions, may cause harmful interference to radio communications. However, there is no guarantee that interference will not occur in a specific installation. If interference does occur to radio or television reception, which can be determined by turning the equipment off and on, the user is encouraged to try to correct the interference by one or more of the following measures:

- Reorient or relocate the receiving antenna.
- Increase the separation between the equipment and the receiver.
- Consult the Customer Care Center.

CAUTION: Modification or changes to this equipment not expressly approved by Radio Systems Corporation may void the user's authority to operate the equipment.

---



### Important Recycling Advice

Please respect the Waste Electrical and Electronic Equipment regulations in your country. This equipment must be recycled. If you no longer require this equipment, do not place it in the normal municipal waste system. Please return it to where it was purchased in order that it can be placed in our recycling system. If this is not possible, please contact the Customer Care Center for further information. For a listing of Customer Care Center telephone numbers, visit our website at [www.petsafe.com](http://www.petsafe.com).

---

## Warranty

### One Year Non-Transferable Limited Warranty

This Product has the benefit of a limited manufacturer's warranty. Complete details of the warranty applicable to this Product and its terms can be found at [petsafe.com](http://petsafe.com) and/or are available by contacting your local Customer Care Center:

Radio Systems Corporation  
10427 PetSafe Way  
Knoxville, TN 37932 USA

Radio Systems Corporation  
10427 PetSafe Way  
Knoxville, TN 37932  
+1 (800) 732-2677

[petsafe.com](https://petsafe.com)

L400-2466

©2020 Radio Systems Corporation