

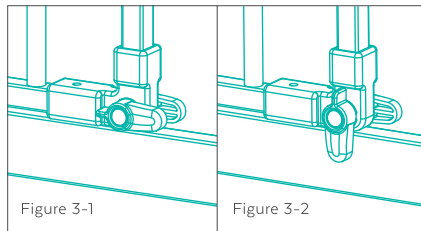

**PART 3 - OPERATE DOOR, BASE LOCKS AND DOOR LATCH**



**STEP 1** Locate the base locks at the bottom of the gate door. Turn one base lock to the horizontal position to open the gate door. The base lock on the side occupied by your pet should be placed in the vertical position.

**TIP:** There are 2 base locks which allows you to modify how the gate swings open.

**TO OPEN DOOR IN AND OUT**

Leave all base locks in the horizontal position (Figure 3-1).

**TO OPEN DOOR IN ONLY**

Turn the base lock on the inside of the gate (where your pet would be) horizontally (Figure 3-2).

**TO OPEN DOOR OUT ONLY**

Turn the base lock on the outside of the gate horizontally.

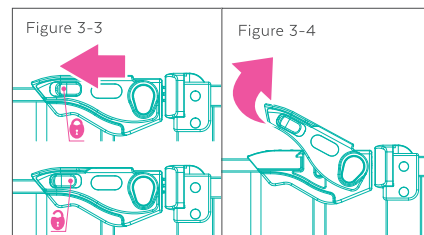
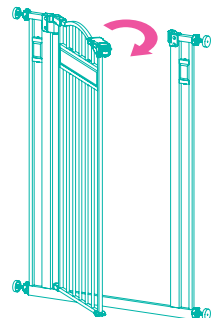

**STEP 2** To open the gate door, locate the door latch. Press both side buttons on the latch and pull up (Figure 3-3 & 3-4).

Once the gate is opened, it will swing shut and lock on its own.

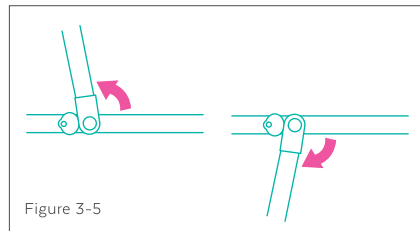

**KEEPING THE DOOR OPEN**

Swing the door past 90 degrees to lock it open (Figure 3-5).

**TROUBLESHOOTING**

**GATE NOT STAYING CLOSED**

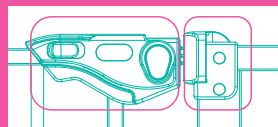

The locking handle is too close to the locking housing. This can be corrected by loosening the upper threaded spindle rods by turning them outward, creating the proper gap.

**GATE NOT STAYING OPEN**

The gate was not installed properly. Remove and reinstall the gate, being careful to ensure that the gate is flat, straight, and perpendicular to the floor.

**REMOVING THE GATE**

To remove the gate, rotate the adjustment wheels on the 4 threaded spindle rods to loosen. This will depressurize the gate so you can remove it with a gentle pull or push.

**CARE AND MAINTENANCE**

Always check the gate and discontinue use if any parts are missing, worn or damaged. Check regularly to make sure all hardware and mountings are tightened securely. Wash with mild detergent. Don't use any abrasive cleaners or bleach.

**WARNINGS AND CAUTIONS**

Please read all warnings and instructions thoroughly before assembling.

- FOR PET USE ONLY. NOT FOR USE WITH CHILDREN.
- Never install this gate without the wall cups!
- Only assemble as directed and using all required parts.
- Never leave pet unattended. Stop using if/once your pet can climb over or push the gate loose.
- Use only with the locking/latching mechanism securely engaged.
- Never use at top of stairs.
- Do not use as a barrier to pool.
- Use the wall cups for stability and safety. Wall cups and assembly hardware are included.
- Install according to assembly instructions. If installed improperly, the gate could become unstable or dislodged from the doorway.

- Always ensure the gate is resting against the floor before beginning installation.
- Never use more than two extensions per side of gate.
- If assembling onto a surface other than drywall or wood, please consult with a professional for proper installation.
- Do not assemble if any part is missing or damaged.
- Check the gate regularly to ensure all hardware and mountings are tightened.
- Keep these instructions handy for future use.
- The gap between the gate and wall should not exceed more than 2.5 inches.

**QUESTIONS?**

CALL OUR FRIENDLY CUSTOMER SERVICE TEAM ANYTIME. WE'RE HERE 24/7! 1-800-67-CHEWY (672-4399)



SKU# 221968  
352631

**WOOD ACCENTS METAL GATE**  
**INSTRUCTION MANUAL**  
FOR PET USE ONLY

## BEFORE ASSEMBLY

**IMPORTANT** - Gate installation is NOT complete without installing wall cups. Both Part 1 and Part 2 must be completed. Open the small box shipped with your package and take out the assembly components you'll need.

## PARTS INCLUDED

Prior to assembly, please be sure to identify and sort all parts shown below.

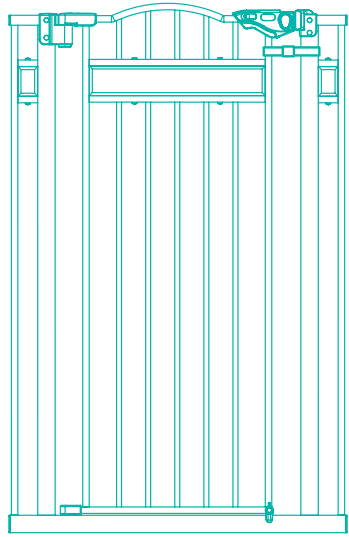

**A Gate Frame (1)**

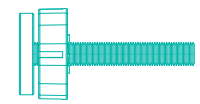

**B Threaded Spindle Rods (4)**



**C Wall Cups (4)**



**D Screws (6)**  
Requires a Phillips screwdriver



**E Spanner (1)**



**F Double Sided Foam Tape (4)**

		EXTENSION INCLUDED		
SKU	DESCRIPTION	6.9 in	8 in	12 in
221968	Frisco Wood Accents Extra Tall Metal Gate, Black	✓		
352631	Frisco Wood Accents Extra Wide Metal Gate, Black	✓	✓	✓

## PART 1 - INSTALL THE GATE

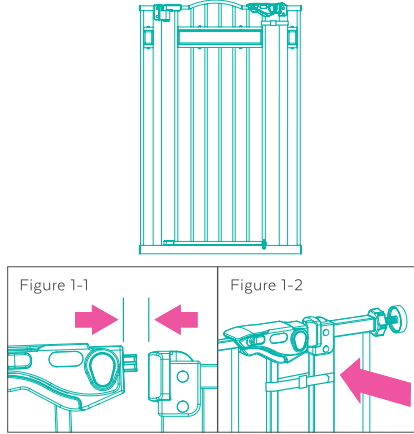

**STEP 1** Set up the gate in a doorway opening where you'd like to use it. Make sure the bottom of the gate is touching the floor and that the gate is not at an angle, i.e. tipping forward or backward. **Do not install at top of stairs.**

**NOTE:** You'll notice a gap between the two sides of the door latch at this point (Figure 1-1). This is normal and the gap will close once you tighten the gate in the doorway opening. **Do not remove the zip tie until installation is complete** (Figure 1-2).

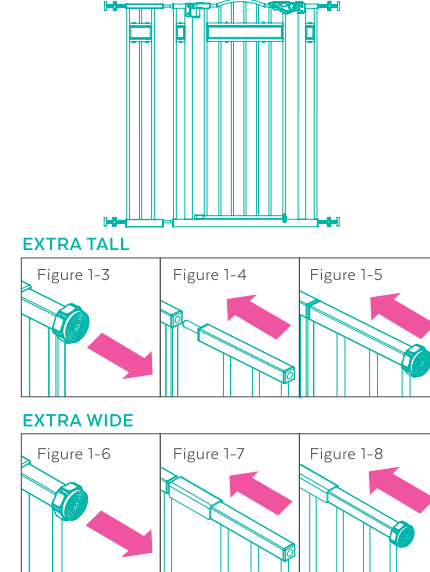

**EXTRA TALL**  
Figure 1-3, Figure 1-4, Figure 1-5

**EXTRA WIDE**  
Figure 1-6, Figure 1-7, Figure 1-8

**ADDING A GATE EXTENSION (OPTIONAL)**  
If using a gate extension, install the extension at this point. Choose the side of the gate to be extended and with the top and bottom threaded spindle rods removed, slide the extension into the gate. Do not use more than two extensions per side of the gate.

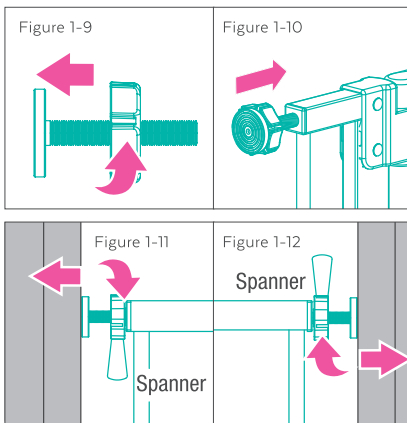

**STEP 2** Locate the threaded spindle rods and twist the adjustment wheels until they are at the midpoint of the bolt (Figure 1-9). Place the threaded spindle rods into all 4 holes at each of the 4 corners on the gate (Figure 1-10). Rotate the adjustment wheels using either your hands or the provided spanner to pressurize the gate against the doorway opening until the gate is secure and the gate door latch connects together.

**TIP:** Spin the spindle rods so they move toward the gate (Figure 1-11 & 1-12).

## PART 2 - ATTACH THE WALL CUPS

**IMPORTANT** - Never install this gate without the wall cups! Setting up the wall cups will make it difficult to relocate the gate. **Therefore, it is IMPORTANT to install the wall cups only after you find the perfect spot for your gate.**

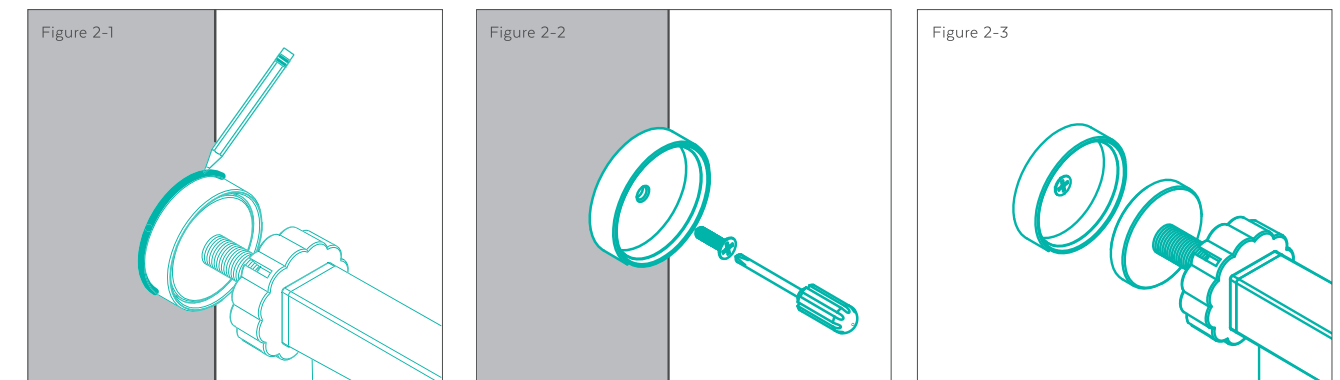

**STEP 1** First, you'll need to mark up where the wall cups should go. Follow steps for Part 1 to set up the gate. Once installed and pressurized, use a pencil to mark the placement of the wall cups by circling where the threaded spindle rods touch the wall (Figure 2-1).

**STEP 2** Locate the wall cups. Place them on the 4 wall markings drawn in Step 1.

**STEP 3** Use the included screws and a Phillips screwdriver to install the wall cups. You can also use the double-sided foam tape provided with the assembly components instead.

**STEP 4** Now follow directions for Part 1 again to set up the gate. This time ensure the threaded spindle rods are securely inserted into the wall cups.

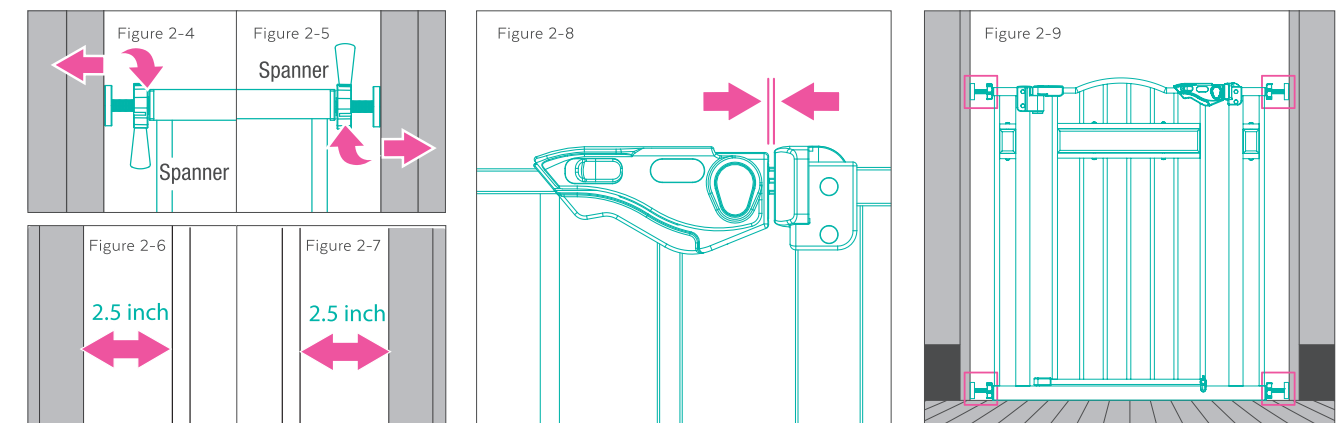

**TIP:** Alternate rotating the adjustment wheels on all 4 sides to ensure equal spacing on all 4 threaded spindle rods (Figure 2-4 & 2-5). The ideal spacing on each side is about 2.5 inches (Figure 2-6 & 2-7).

**NOTE:** The ideal placement for the gate is completely flat on the floor with a maximum floor clearance of 3/16 of an inch.

**STEP 5** Make sure to maintain a gap of .060 - .080 of an inch (the thickness of a nickel/penny) between the left and right parts of the door latch (Figure 2-8).

**STEP 6** Check that the gate is properly installed by giving the frame a light tug and ensuring all the corners are secure with the threaded spindle rods and wall cups.

**TIP:** You should not be able to spin the spindle rods toward the gate any further.