

CAT LITTER

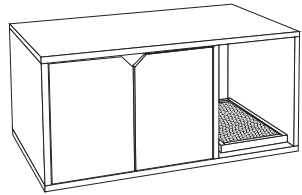

Included

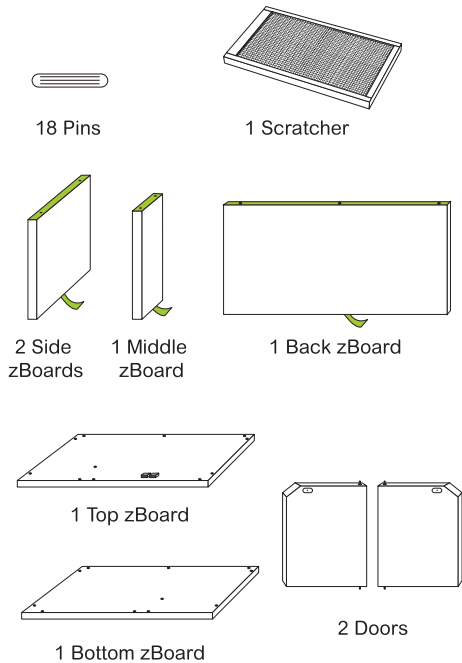

WARNING: CHOKING HAZARD
Small parts NOT for children under 3 years

Important

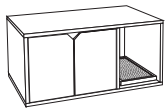

THIS SIDE UP

CAUTION placing unit on its side or back will compromise structural integrity. Use right side up.



- Assemble your unit on a flat even surface
- Make sure zBoard surfaces are clean and dry

- When moving your Way Basics unit, lift from the bottom
- Indoor use only. Not in bathroom.

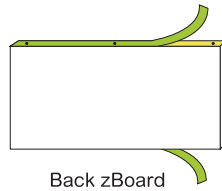

1 Carefully remove the protective layer leaving the 3M adhesive on zBoard (adhesive shown in yellow).

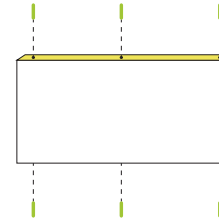

2 Insert alignment pins to back zBoard.

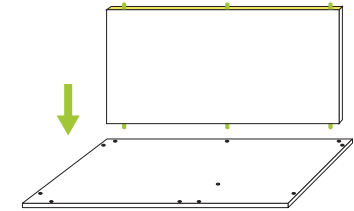

3 Align back zBoard to horizontal zBoard. Press down firmly.

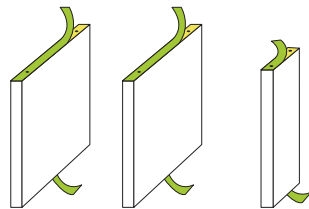

4 Remove adhesive from side zBoards and middle zBoard.

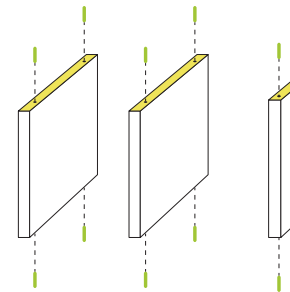

5 Insert alignment pins to side zBoards and middle zBoard.

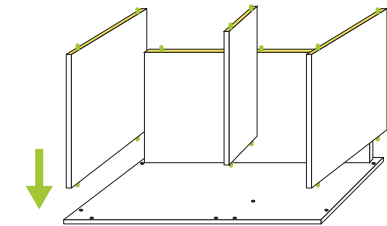

6 Align vertical zBoards to horizontal zBoard as shown. Press down firmly.

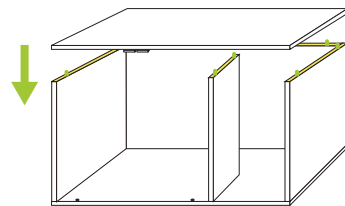

7 Align horizontal zBoard to unit as shown. Press down firmly.

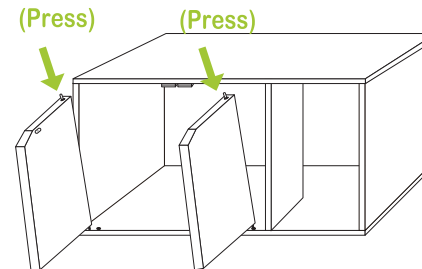

8 Orient door properly as shown and align bottom pin. Press on spring loaded top pin and insert.

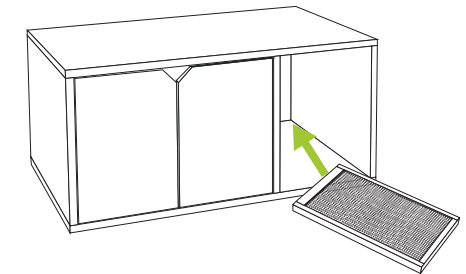

9 Place cat scratcher in unit. Put your cat litter box inside doors.



IT'S NOT WOOD! Thank you for saving trees



Simple

World's Easiest Assembly



Safe

Zero Formaldehyde or VOC



Eco

99% recycled 100% recyclable

flip for assembly guide 



Paper products are recycled after use

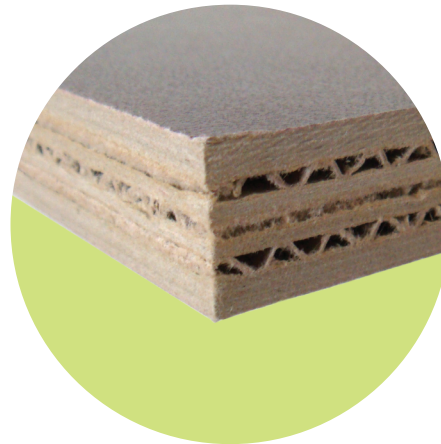

We use this recycled paper to create **zBoard**



zBoard products create a healthier world, healthier you!



Thank you for choosing Way Basics. At Way Basics we stand behind our products with a LIFETIME GUARANTEE. Your happiness is important to me and it's our goal to provide a 5-star-service with every purchase. Please call, text, or email me for help!

Jimmy Chiang

Way Basics Founder
jimmy@waybasics.com 949-229-1662

LET US
HELP

No need to return

