

9. Lift and pull backward the mesh cover on the top, and the mesh cover can slide out along the sliding channel. Then the user can put pet and ornaments in the terrarium and also feed the pet.

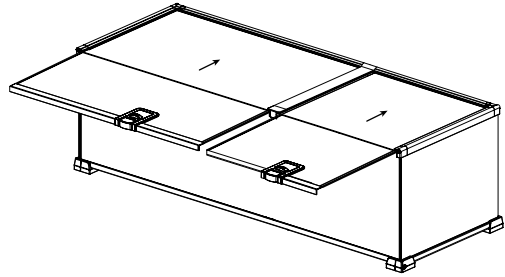

10. After decorating the terrarium inside, sort out power cords in the outlet hole and push top mesh cover to close. Fill the outlet hole with a rubber cap if there is no power cord.

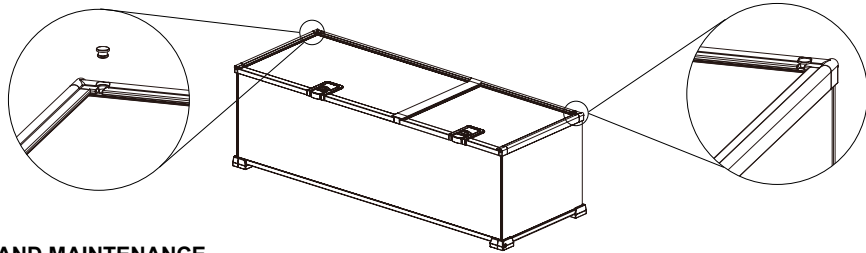

#### SAFETY AND MAINTENANCE

1. Please read carefully instruction manual and follow below safety instructions before using this product.
2. Do not place the terrarium in damp areas or places exposed to direct sunlight, such as bathroom or balcony.
3. A PVC tray is provided at the bottom inside the terrarium which can hold a small amount of water. Therefore make sure the terrarium is placed horizontally without inclination.
4. Except for stack with same size of terrarium, do not place any heavy objects onto the top of mesh cover to avoid damage or deformation of the mesh cover due to heavy weight.
5. To hang a lamp over the terrarium, the user should adjust the lamp position according to actual situation to prevent the pet from overheating or getting scalded by uncontrolled heat emitted by the lamp due to long time working.
6. To prevent the mesh cover from overheating, when hanging a lamp over the terrarium, there should be at least 2cm distance between the bottom of the lamp and the mesh cover of the terrarium.
7. When moving the terrarium, the user should handle it with care and should not move it with wet hands. When moving the terrarium which has been landscaped, the user should be aware that objects inside it may incline or fall and cause the terrarium to break if it is subject to uneven forces.
8. This product can not be assembled by children alone. When a young child uses the terrarium, there should be an adult at his side to supervise and guide him.
9. If some trouble happens to the terrarium, please do not try to fix it on your own. You can contact us for proper handling if you have any question.
10. If the user fails to obey the above requirements and causes any damage to the product or accident due to that, the manufacturer has no responsibility for it.

## KNOCK-DOWN MINI GLASS HABITAT INSTRUCTION MANUAL

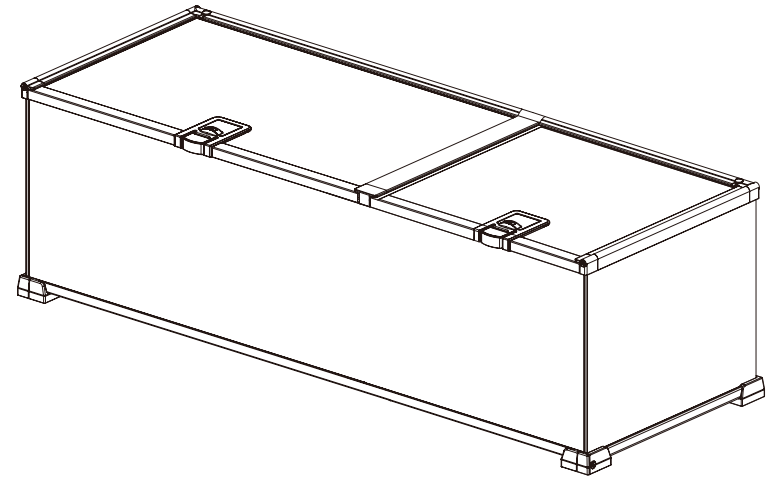

Thanks for choosing REPTIZOO knock-down mini glass habitat. In order to use this knock-down mini glass habitat properly and ensure its service life, please read the instructions manual carefully before using it.

## PRODUCT OVERVIEW

Introducing new patent design, RAK terrarium is a glass terrarium enabling easy disassembly and assembly and 360° full view observation. The terrarium body consists of six parts including a base, two side boards, a front board, a back board and a mesh cover with just six screws locking them together. Inside the terrarium body is a PVC tray which can hold water and can be easily taken out or put in and cleaned. The mesh cover has unique food feeding opening and thread pulling opening and "lift and pull" sliding switch design, making the product more elegant and pragmatic.

Thanks for selecting REPTIZOO product. Before using this product, please read carefully this instruction manual.

## PRODUCT LIST

- |                                |                                   |
|--------------------------------|-----------------------------------|
| 1. Terrarium front board: 1pc  | 7. Mesh cover: 2pc                |
| 2. Terrarium back board: 1pc   | 8. Transparent PVC tray: 1pc      |
| 3. Terrarium bottom board: 1pc | 9. Stainless screw: 6pcs (KA4x25) |
| 4. Terrarium left board: 1pc   | 10. Simple screwdriver: 1 pc      |
| 5. Terrarium right board: 1pc  | 11. Gloves: 1pair                 |
| 6. Rubber cap: 2pcs            | 12. Dividing strip:1 pc           |

## PRODUCT FEATURES

1. It offers an experience of 360°full view observation which can enhance the interaction between the pet and the user.
2. It employs new patent structure design, enabling easy assembly and disassembly of it. It's simple but pragmatic.
3. Small size of the terrarium package enables easy storage and management of it.
4. Transparent PVC bottom tray is provided to avoid liquid leakage and enable convenient cleaning.
5. Safety lock structure effectively prevents the pet from escaping.
6. Uniquely designed food feeding opening is reserved on the mesh cover, making it elegant and pragmatic.

## OPERATION METHOD

1. Unpack the product and confirm quantity and category of the accessories and place them properly according to product list in the instruction manual.
2. First, place the base onto a stable platform and make sure the groove of the slide channel on the base faces the front.



3. Insert the left and right boards along the sliding channels on the base and push them to the end.

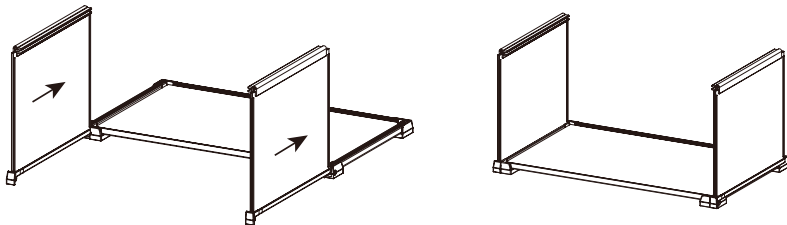

4. Insert vertically the back board along rear ends of the left and right boards and make sure the connection area of left board, right board and back board are at the same horizontal level. Then lock them with screws vertical to the back board.

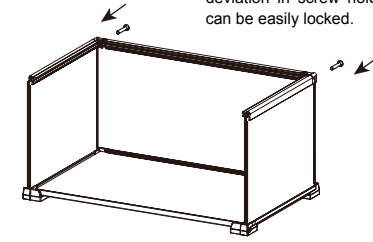
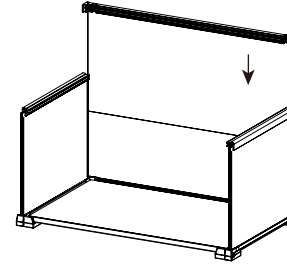

Note: Lock the screws halfway to avoid any deviation in screw holes, and other screws can be easily locked.

5. Insert vertically the front board along front ends of the left and right boards and make sure the connection area of left board, right board and front board are at the same horizontal level. Then lock them with screws vertical to the front board.

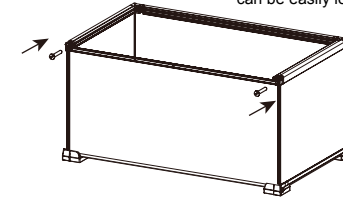
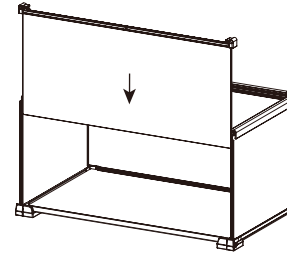

Note: Lock the screws halfway to avoid any deviation in screw holes, and other screws can be easily locked.

6. Fasten the left board, right board and front board with screws vertical to the left and right boards. And complete all other screws locking.

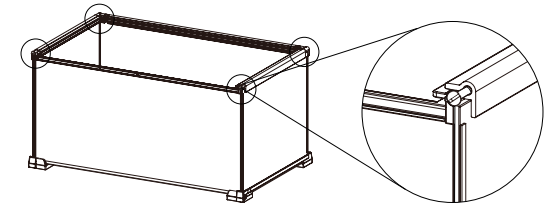
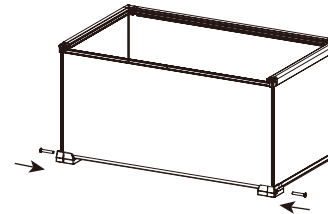

7. Put the PVC tray into the bottom of the terrarium after wiping it with soft cloth or sponge.
8. Push the mesh cover along the sliding channels of left and right boards to the end. Now the terrarium has been completely assembled.

