

frisco.
better pet goods

72"
HEIGHT

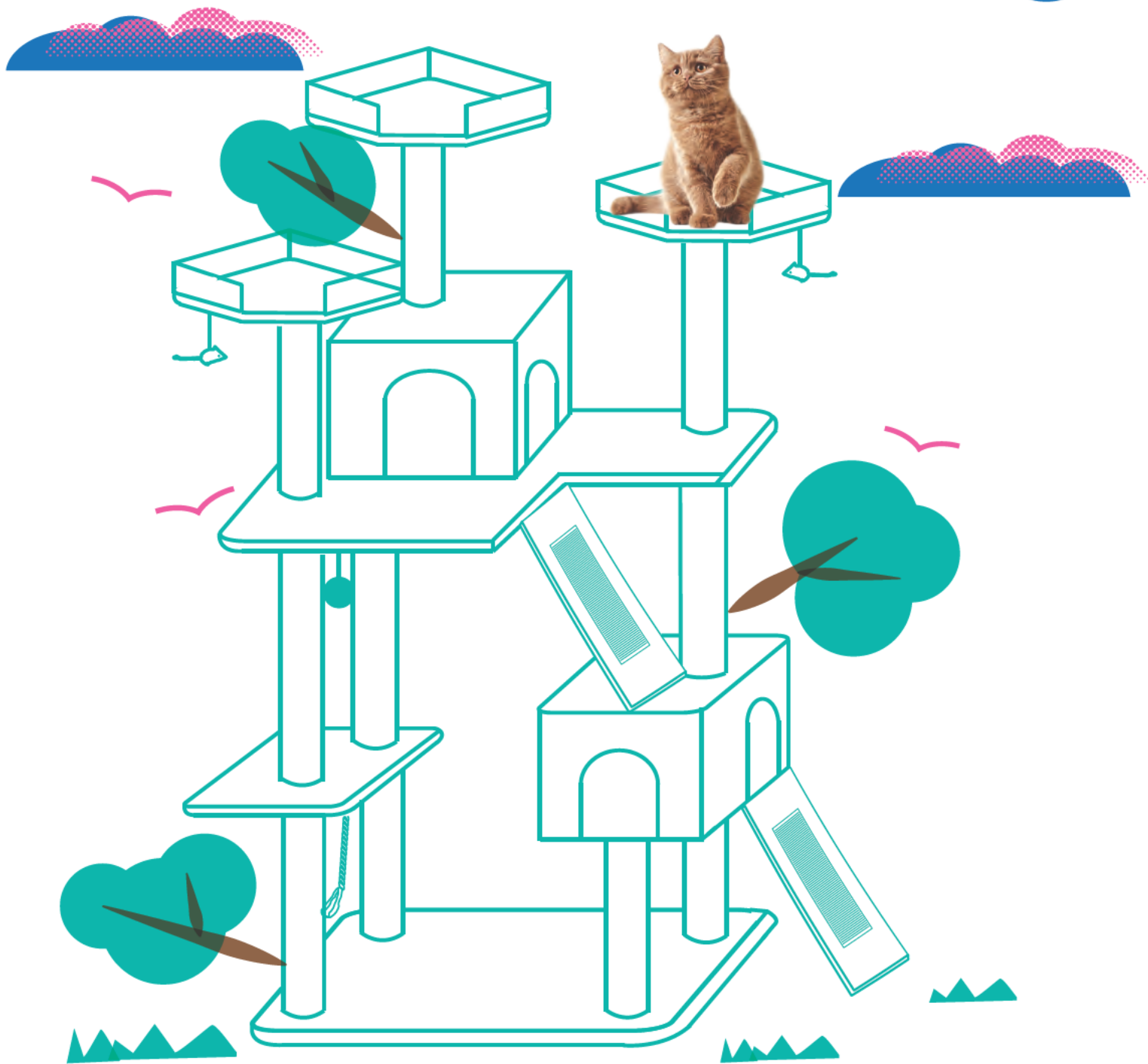

SKU# 92257,101809

OVERALL DIMENSIONS

72"H x 44"W x 27.5"L

BASEBOARD DIMENSIONS

27.5"W x 23.5"L

CAT TREE

INSTRUCTION MANUAL

WARNINGS & CAUTIONS

PLEASE READ AND FOLLOW ALL WARNINGS AND INSTRUCTIONS TO AVOID PET INJURY OR PROPERTY DAMAGES.

- Keep all tools and instructions in a safe place for future reference.
- Follow the instructions carefully and make sure you've completed each step.
- This cat tree is intended for cat use only, please keep children away.
- Keep all small parts away from children/pets to avoid choking hazards.
- Never climb, rock, shake, step or hang on the cat tree.
- Place your cat tree indoors, away from direct sunlight or damp areas.
- Cat trees should be placed on a flat, level surface for stability.
- Check your cat tree often for loose screws or parts that might need re-tightening.
- If your cat tree gets torn or damaged, please discard it.
- The product photo may vary slightly from your fully assembled cat tree as this product is continually being enhanced.

CLEANING INSTRUCTIONS

Spot clean stains and vacuum fur (using small handheld or attachment) when necessary.

COMPONENTS

Prior to assembly, be sure to identify and sort all components shown below.



1
1PC
Baseboard

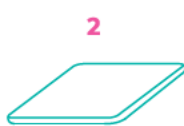

2
1PC
Platform

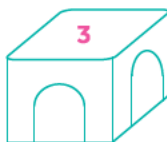

3
1PC
Apartment

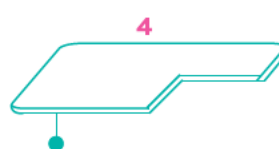

4
1PC
Platform

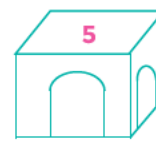

5
1PC
Apartment

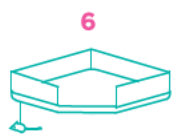

6
1PC
Perch

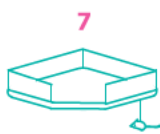

7
1PC
Perch

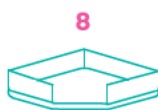

8
1PC
Perch



9
1PC
Scratching Board



10
1PC
Scratching Board



11
4PCS
Scratching Post
520mm

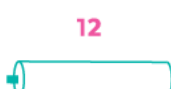

12
2PCS
Scratching Post
380mm



13
1PC
Scratching Post
380mm



14
2PCS
Scratching Post
430mm



15
1PC
Scratching Post
445mm



16
1PC
Rope

A		40mm Bolt	6PCS
B		70mm Bolt	1PC
C		85mm Double-sided Bolt	4PCS
D		Bracket	3PCS
E		16mm Bolt	9PCS
F		Bracket	1PC
G		Bracket	1PC
H		30mm Screw	1PC
I		18mm Washer	1PC
J		30mm Drywall Anchor	1PC
K		35mm Bolt	1PC
		5mm Wrench	1PC
		4mm Wrench	1PC

ASSEMBLY INSTRUCTIONS

STEP 1

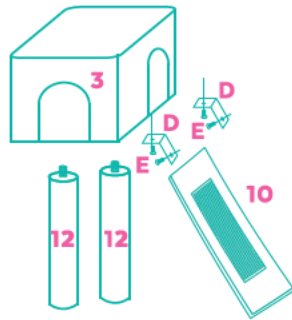

STEP 2

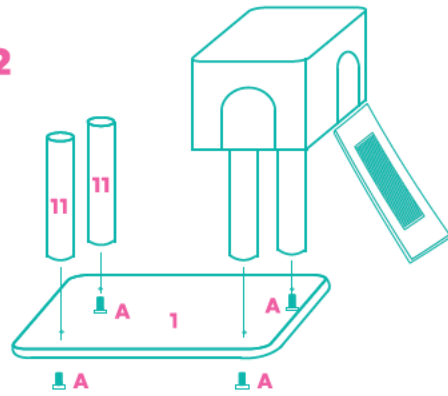

STEP 3

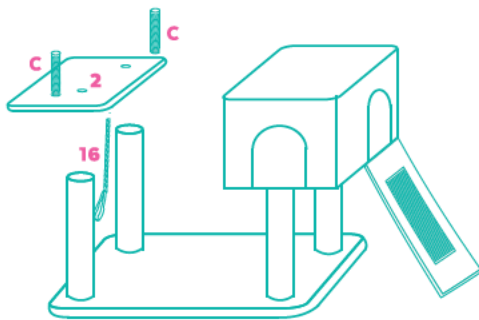

STEP 4

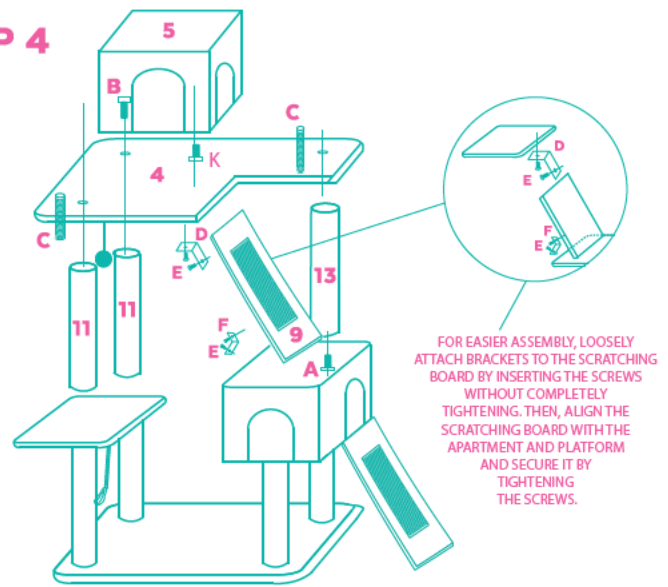

STEP 5

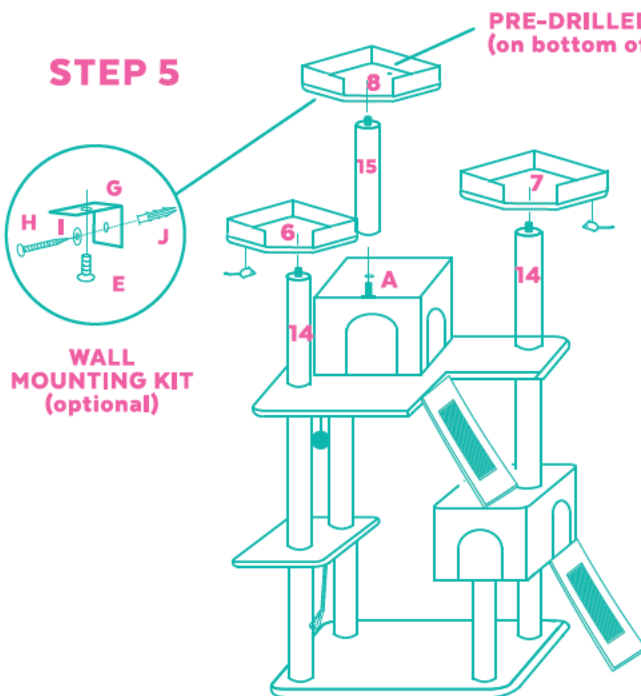

FINISHED ASSEMBLY

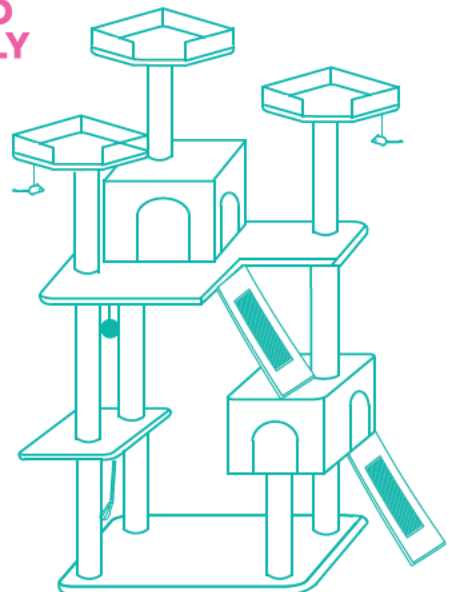

FULL ASSEMBLY

WALL MOUNTING KIT (optional)

PRE-DRILLED HOLE (on bottom of perch)

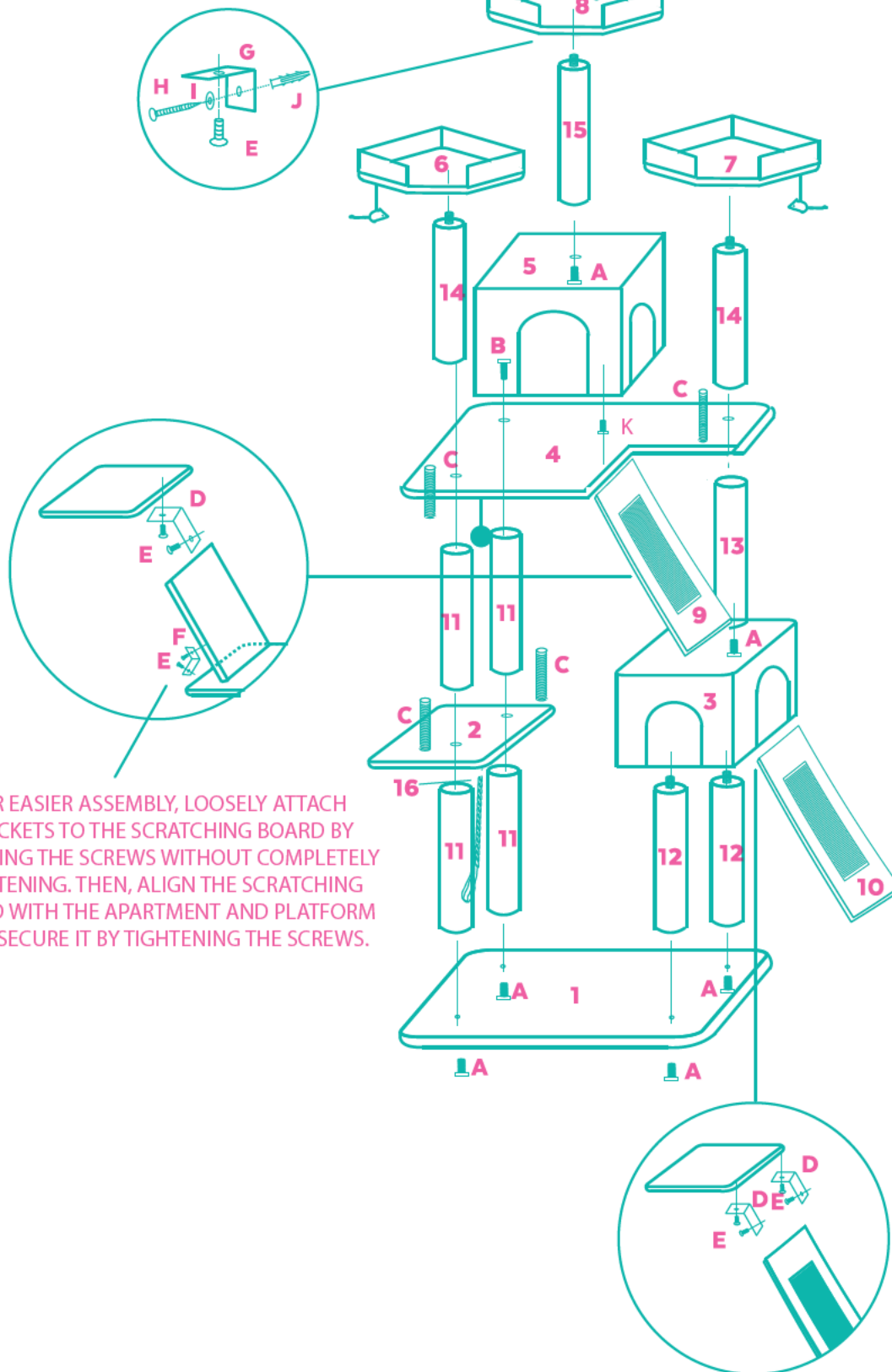

FOR EASIER ASSEMBLY, LOOSELY ATTACH BRACKETS TO THE SCRATCHING BOARD BY INSERTING THE SCREWS WITHOUT COMPLETELY TIGHTENING. THEN, ALIGN THE SCRATCHING BOARD WITH THE APARTMENT AND PLATFORM AND SECURE IT BY TIGHTENING THE SCREWS.