

frisco.[™]
better pet goods

62"
HEIGHT



SKU# 92259, 101795
OVERALL DIMENSIONS
62"H x 33.5"W x 31"L
BASEBOARD DIMENSIONS
24.75"W x 20.75"L

CAT TREE

INSTRUCTION MANUAL

WARNINGS & CAUTIONS

PLEASE READ AND FOLLOW ALL WARNINGS AND INSTRUCTIONS TO AVOID PET INJURY OR PROPERTY DAMAGES.

- Keep all tools and instructions in a safe place for future reference.
- Follow the instructions carefully and make sure you've completed each step.
- This cat tree is intended for cat use only, please keep children away.
- Keep all small parts away from children/pets to avoid choking hazards.
- Never climb, rock, shake, step or hang on the cat tree.
- Place your cat tree indoors, away from direct sunlight or damp areas.
- Cat trees should be placed on a flat, level surface for stability.
- Check your cat tree often for loose screws or parts that might need re-tightening.
- If your cat tree gets torn or damaged, please discard it.
- The product photo may vary slightly from your fully assembled cat tree as this product is continually being enhanced.

CLEANING INSTRUCTIONS

Spot clean stains and vacuum fur (using small handheld or attachment) when necessary.

COMPONENTS

Prior to assembly, be sure to identify and sort all components shown below.

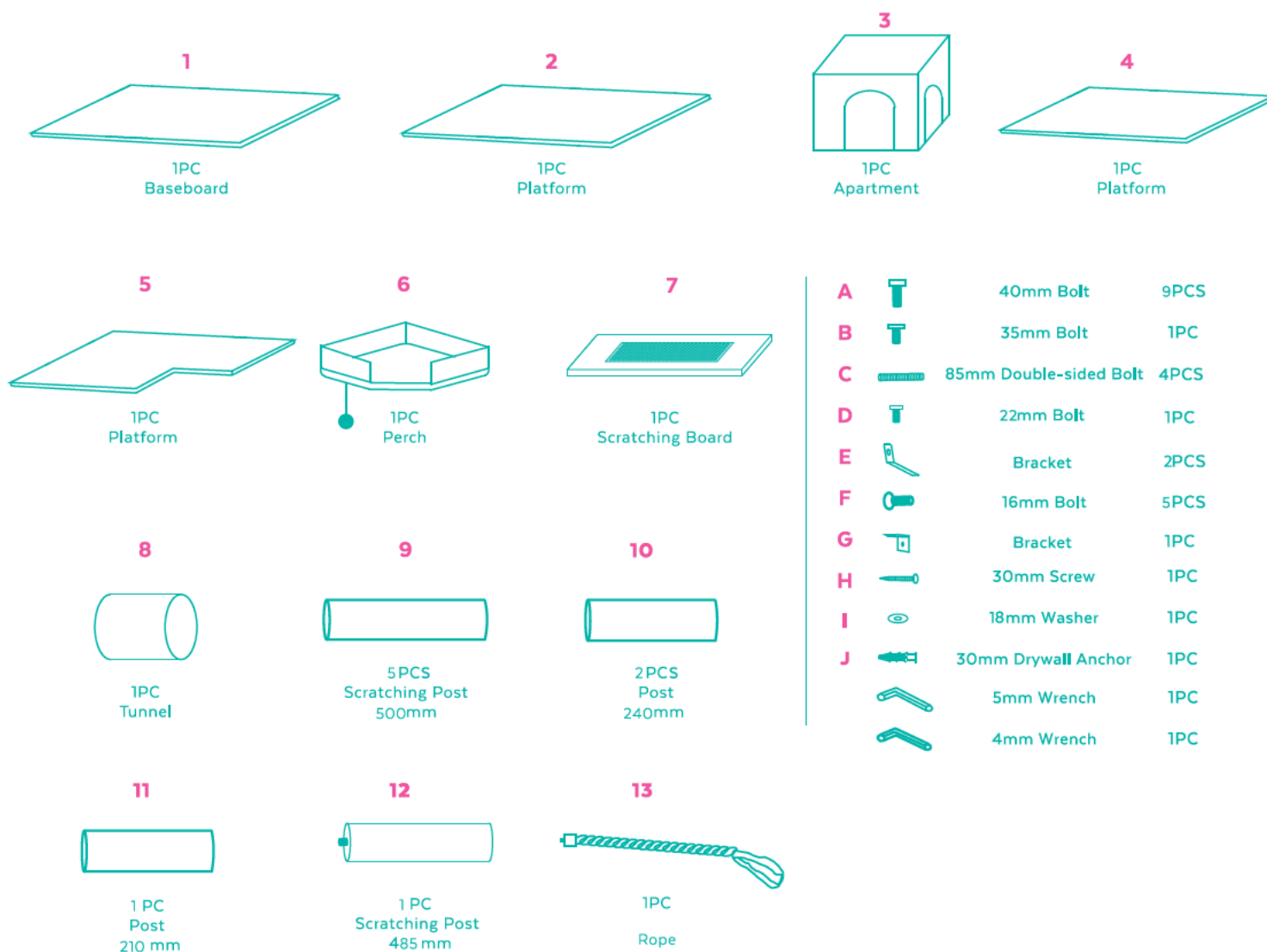

ASSEMBLY INSTRUCTIONS

STEP 1

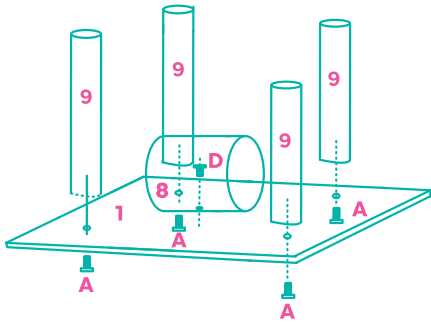

STEP 2

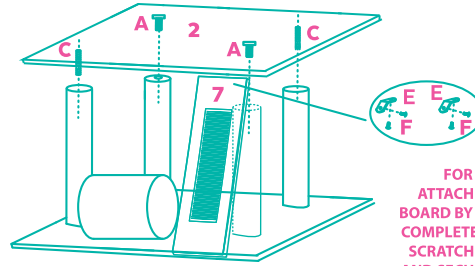

FOR EASIER ASSEMBLY, LOOSELY ATTACH BRACKETS TO THE SCRATCHING BOARD BY INSERTING THE SCREWS WITHOUT COMPLETELY TIGHTENING. THEN, ALIGN THE SCRATCHING BOARD WITH THE PLATFORM AND SECURE IT BY TIGHTENING THE SCREWS.

STEP 3

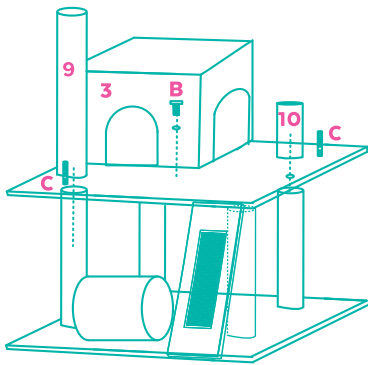

STEP 4

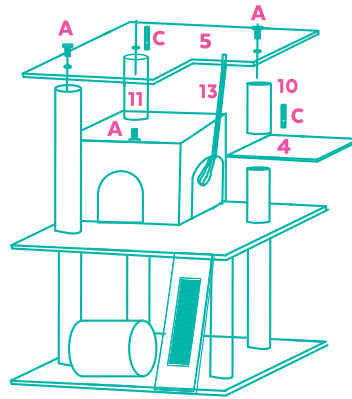

STEP 5

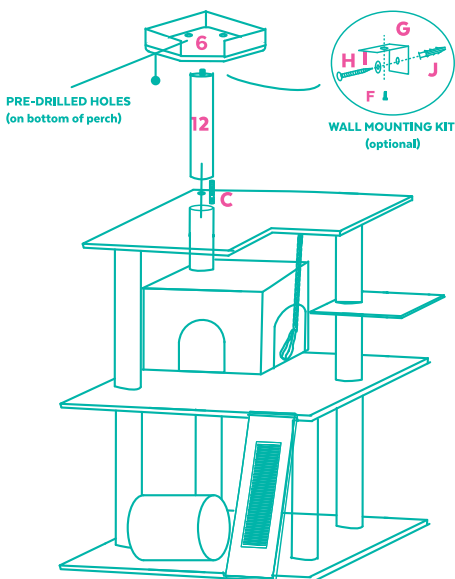

FINISHED ASSEMBLY

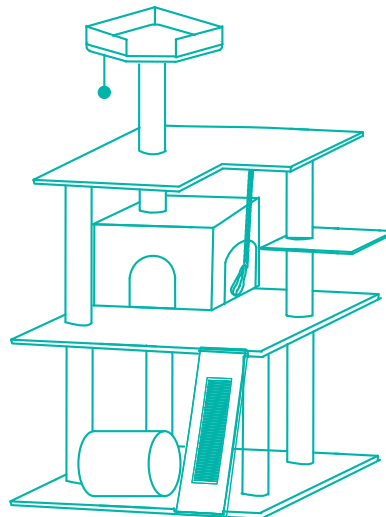

FULL ASSEMBLY

